



C.R.I. PUMPS

Pumping trust. Worldwide.

SUBMERSIBLE PUMPS AND MOTORS

50Hz







C.R.I. PUMPS

Pumping trust. Worldwide.

T H E B E G I N N I N G

of C.R.I., way back in 1961, was a resolute attempt to produce a few irrigation equipments using the limited facilities of an in-house foundry. Eventually the founder's dream was coming true as the small production unit he started kept growing rapidly. Now, after more than five eventful decades, it is an enormous, widely reputed organization, which produces more than 2300 varieties of perfectly engineered pumps and motors and sells its products in numerous countries spread across 6 continents.

C . R . I . I S O N E A M O N G

the few pioneers in the world to produce 100% stainless steel submersible pumps. Having achieved a record production capacity of over 2 million pumps per annum, today C.R.I. is rubbing its shoulders with the best brands in the world, with advanced technology and safety standards as its hallmarks.

T H E I N F R A S T R U C T U R E

of C.R.I. is pretty comprehensive with state-of-the-art machineries and high potential in-house R&D recognised by the ministry of science and technology, Govt. of India - all within its own covered area of 300,000 square metres. The production environment is accredited with ISO 9001, ISO 14001 & OHSAS 18001 certifications and the products are CE, UR/UL, IEC, TSE & ISI certified. The R&D team always stays in tune with the changing scenario and seldom fails in coming up with outstanding solutions every time.

N E E D L E S S T O S A Y ,

behind this legendary growth lies the untiring, innovative, enthusiastic and dedicated team work. and, of course, a flawlessly maintained value system too. The name C.R.I. itself encapsulates the company's ethos: " Commitment, Reliability, Innovation".





C.R.I. FLUID SYSTEMS

Pumping trust. Worldwide.

Vision, Mission and values

To be the industry leader providing best - in - class fluid management solutions to individual and institutional customers and societies in our chosen markets.

We will achieve this through our dedicated efforts to enhance the welfare of all our stakeholders and by living by our values of commitment, reliability and Innovation.

C O N T E N T S

Page No.

STAINLESS STEEL SERIES	
General Information	04
Group Performance curves	09
Material of Construction	12
Exploded views	13
Performance tables and curves	18
SILVER LINE SERIES	
General Information	88
Group Performance curves	89
Material of Construction	91
Exploded views	92
Performance tables and curves	96
Reference Tables	166
MODEL IDENTIFICATION CODE	
	117
OIL FILLED SUBMERSIBLE MOTORS	
4" Motors	
Description, Features and Applications	118
Exploded View	119
Technical Specifications and Materials of Construction	121
Technical Data	122
RESIN FILLED ENCAPSULATED SUBMERSIBLE MOTORS	
4" Motors	
Description, Features and Applications	123
Exploded View	123
Technical Specifications and Materials of Construction	125
Technical Data	126
WATER FILLED REWINDABLE SUBMERSIBLE MOTORS	
Description, Features & Applications	127
Exploded View	128
4" Motors	
Technical Specification and Materials of Construction	138
Technical Data	139
6" Motors	
Technical Specification and Materials of Construction	140
Technical Data	141
7" Motors	
Technical Specification and Materials of Construction	147
Technical Data	148
8" Motors	
Technical Specification and Materials of Construction	149
Technical Data	150
10" Motors	
Technical Specification and Materials of Construction	151
Technical Data	152
12" Motors	
Technical Specification and Materials of Construction	154
Technical Data	155
Pipe Friction Loss Table	158
Conversion Table	160

GENERAL INFORMATION

STAINLESS STEEL & SILVERLINE SERIES

PERFORMANCE CURVE CONDITIONS

The conditions below apply to the curves shown on the following pages.

- a. The Performance curve shows pump performance at rated speed, voltage and @ 3 metre minimum submergence.

The nominal speed of pump

4" : n = 2900 rpm

6" : n = 2900 rpm

8" & 10" : n = 2900 rpm

- b. The measurements were made with airless water at 20°C. When pumping liquids with a density higher than that of water, motors with correspondingly higher outputs must be used.
- c. Pipe friction losses have not been included in the performance curves and performance tables.
- d. The bold curves indicate the recommended performance range.
- e. Q/H : The curves are inclusive of check valve and suction inter-connector losses at the actual speed.
- f. Efficiency curve: “ η %” shows pump stage efficiency.
- g. Curve tolerance according to ISO : 9906, Grade-3B
- h. The performances are at rated voltage and are only Indicative. Actual discharge depends on availability of water in well, based on strength of water source, height of water column, submergence of pump, etc.,.
- i. All mounting dimensions are in accordance with NEMA / International standards.
- j. The outlet size of the pumps are as per BSP standard.

GENERAL INFORMATION

STAINLESS STEEL & SILVER LINE SERIES MODEL IDENTIFICATION CODE

DEEPWELL SUBMERSIBLE PUMP

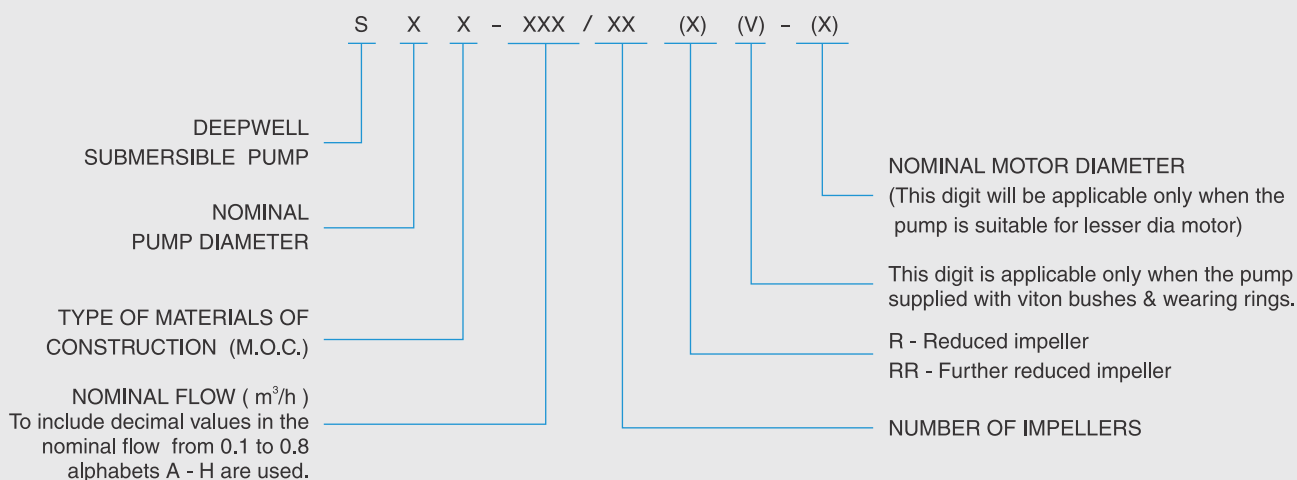

<u>DEEPWELL SUBMERSIBLE PUMP SET (Pump + Motor)</u>	
PUMP MODEL	MOTOR MODEL
S X X - XXX / XX	X X X - XXX X
<u>DEEPWELL SUBMERSIBLE PUMP SET (Pump + Motor)</u>	
PUMP MODEL	MOTOR MODEL
S6S - 18 / 03	W6A - 22 T

STAINLESS STEEL S E R I E S



Submersible Pumps

C.R.I. Submersible Pumps are the products of the expertise gained from over five decades of experience, endurance and workmanship. These products are engineered to perfection with utmost care and stringent quality control at all stages to ensure a trouble free service.

Description : C.R.I. 4", 6", 8" & 10" Stainless steel series submersible pumps are made of corrosion resistance stainless steel with built in check valve. All vital components of these pump models are made of high quality 304 / 316 grade stainless steel and the shaft is of S.S 304 / 329 / 431. The optimal design of impellers and diffusers enables the best possible hydraulic efficiency.

These pumps are of multistage centrifugal type, which can be firmly coupled to a submersible electric motor, which operates submerged beneath the surface of water. Built in check valve prevents back flow, and reduces the risk of water hammer. All mounting dimensions of pumps and motors are in accordance with NEMA standards. C.R.I. submersible pumps can be offered with either C.R.I. 'W' series, water filled rewindable submersible motors / C.R.I. 'R' series, Resin Filled encapsulated (water lubricated) submersible motors / C.R.I. 'L' Series, Non-toxic liquid filled submersible motors or any other NEMA / International standard motors.

Features :

- Best operating efficiency
- Precise parts made of SS 304/316
- Highly durable & Hygiene
- Can be easily dismantled and repaired
- Can handle maximum upthrust loads in its category
- Additional intermediate bearings support in higher stage pumps
- SS 329 spline coupling for longer life

Applications :

- Residential
- Irrigation
- Gardens
- Golf Course
- Fountains
- Industrial & Rural community water supply
- Sprinkler irrigation Systems
- Oil & Gas
- De-watering in mines

STAINLESS STEEL SERIES

PUMPED LIQUIDS

Clean, thin, non-aggressive, non explosive, clear, cold, fresh water without abrasives, solid particles or fibre having the following characteristics

a)	Temperature (max)	NBR - 33°C / VITON - 90°C
b)	Permissible amount of sand	50g/m ³ (max)
c)	Chlorine ion density	500 ppm (max)
d)	Allowable solids	3000 ppm (max)
e)	Specific gravity	1.004 (max)
f)	Hardness (Drinking water)	300 (max)
g)	Viscosity	1.75 x 10 ⁻⁶ m ² /sec (max)
h)	Turbidity	50 ppm silica scale (max)
i)	pH	6.5 to 8.5

PUMP OPERATING LIMITATIONS					
Nominal Diameter		4"(100mm)	6"(150mm)	8"(200mm)	10"(250mm)
Power Range		0.37 - 11 kW	2.2 - 63 kW	5.5 - 130 kW	9.3 - 220 kW
Speed		2900 rpm	2900 rpm	2900 rpm	2900 rpm
Discharge Range	m ³ /h	0.4 - 19	7 - 120	20 - 126	18 - 280
	lps	0.12 - 5.28	1.94 - 33.33	5.5 - 35	5 - 77.78
Total head range	m	4.0 - 535	4.5 - 850	8 - 518	6 - 488
	ft	13.0 - 1755	15 - 2788	26 - 1558	19.68 - 1600
Outlet size in inches		1¼, 1½ & 2	2, 2½, 3 & 4	4 & 5	6
Shaft Coupling		Splines	Splines	Splines	Keyway / Splines

Maximum temperature of Pumped liquid

Motor	Minimum cooling flow along the motor	Vertical installation	Horizontal installation (minimum 30° angle)	Maximum operating pressure	
4" & 6"	0.15 m/s	NBR-33°C	NBR-33°C	4" Submersible pump	5.4 Mpa (54 bar)
8" & 10"	0.16 m/s			6" Submersible pump	6.2 Mpa (62 bar)
4" to 10"	0.5 m/s	VITON-90°C	VITON-90°C	8" Submersible pump	4.8 Mpa (48 bar)
				10" Submersible pump	4.9 Mpa (49 bar)

GENERAL INFORMATION

Group Performance Curves - 4"

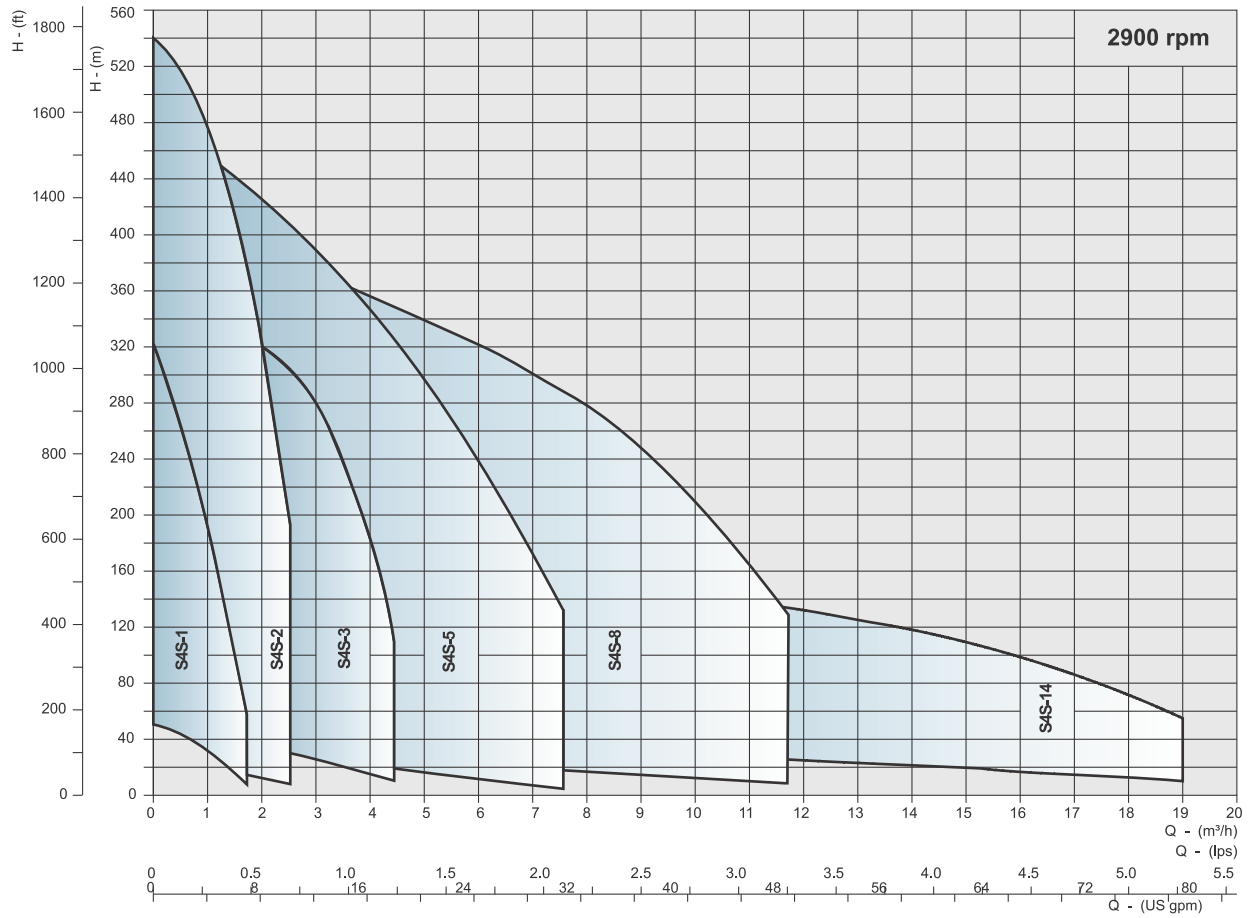

In view of continuous developments, the informations / descriptions / specifications / illustrations are subject to change without notice. Refer general information for performance curve conditions and for other details. Curve tolerance according to ISO : 9906, Grade 3B

STAINLESS STEEL SERIES

Group Performance Curves - 6"

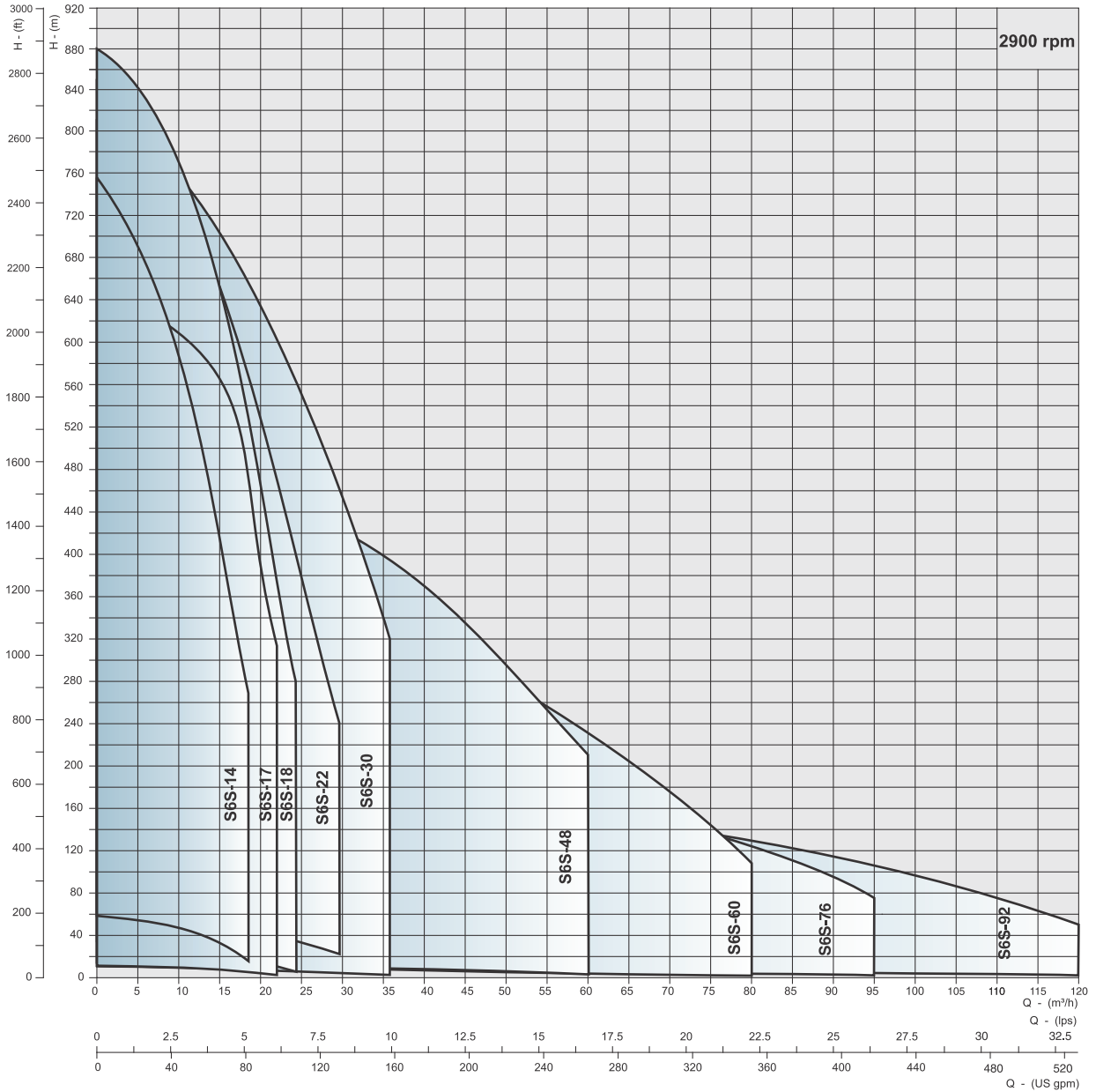

In view of continuous developments, the informations / descriptions / specifications / illustrations are subject to change without notice. Refer general information for performance curve conditions and for other details. Curve tolerance according to ISO : 9906, Grade 3B

GENERAL INFORMATION

Group Performance Curves - 8" & 10"

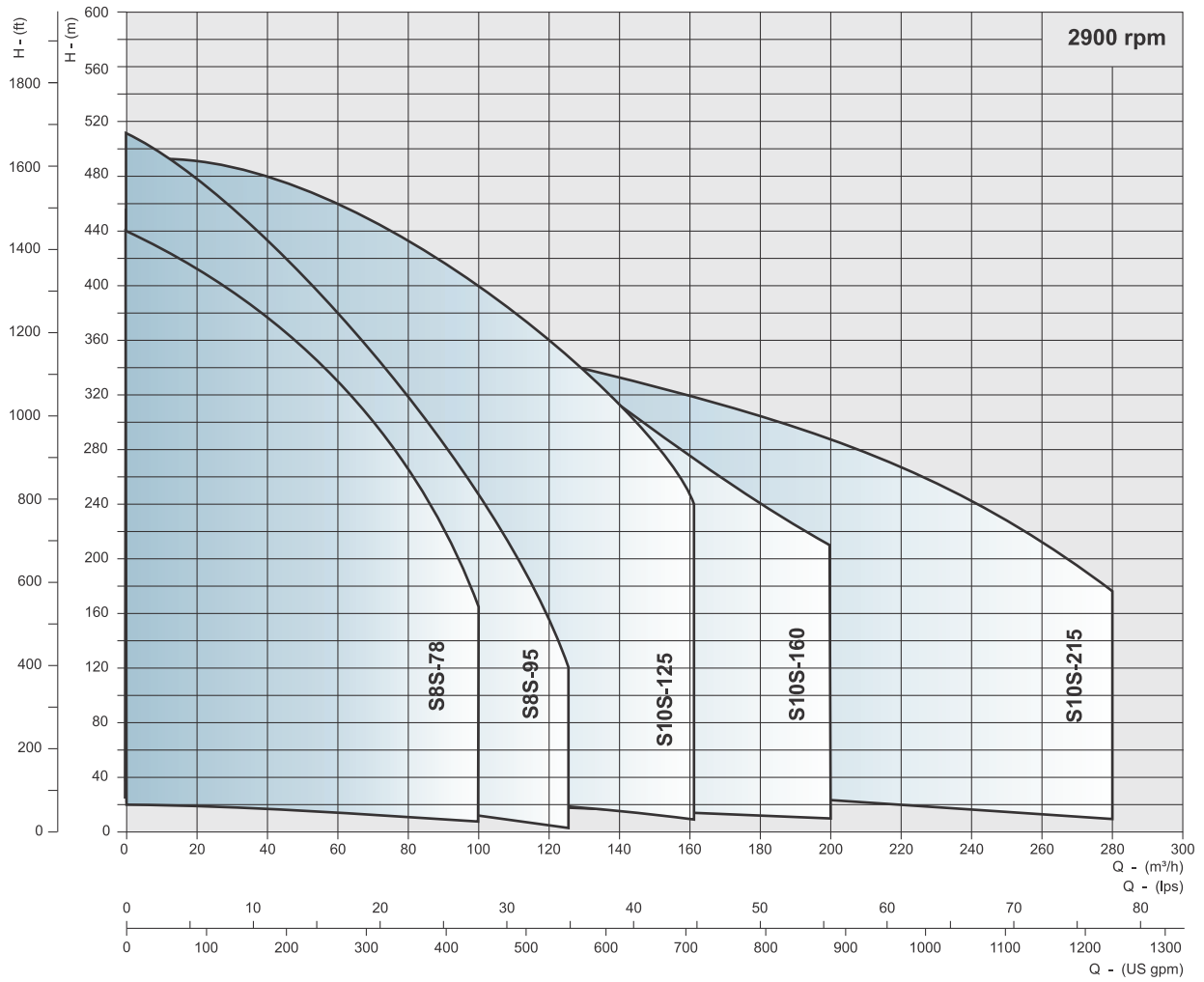

In view of continuous developments, the informations / descriptions / specifications / illustrations are subject to change without notice. Refer general information for performance curve conditions and for other details. Curve tolerance according to ISO : 9906, Grade 3B

STAINLESS STEEL SERIES

Materials of Construction

PART NAME	PART No.	NOMINAL DIA. 4"		NOMINAL DIA . 6", 8" & 10"		
		TYPE - S	TYPE - N	TYPE - S	TYPE - N	TYPE - O
CHECK VALVE HOUSING	21.00	S.S - 304	S.S. - 316	S.S. - 304	S.S. - 316	904 L
CHECK VALVE DISC	21.06	S.S - 304	S.S. - 316	S.S. - 304	S.S. - 316	904 L
CHECK VALVE SEAT	21.01	NBR / FKM	NBR / FKM	NBR / FKM	NBR / FKM	FKM
DIFFUSER CHAMBER	18.03	S.S - 304	S.S. - 316	S.S. - 304	S.S. - 316	904 L
IMPELLER	19.00	S.S - 304	S.S. - 316	S.S. - 304	S.S. - 316	904 L
SPLIT CONE WITH NUT**	19.02	S.S - 304	S.S. - 316	S.S. - 304	S.S. - 316	904 L
IMPELLER WEAR RING / SEAL RING	17.01	NBR / FKM	NBR / FKM	NBR / FKM	NBR / FKM	FKM
UPTHRUST WASHER / STOP RING	13.03	S.S - 304 / TEFLON S.S - 420 / BRONZE	S.S - 316 / TEFLON	S.S. - 420 / CARBON	S.S. - 329 / CARBON	S.S. - 329 / CARBON
INTERMEDIATE BEARING	18.07	NBR / FKM	NBR / FKM	NBR / FKM	NBR / FKM	FKM
SUCTION INTER CONNECTOR	17.00	S.S. - 304	S.S - 316	S.S. - 304	S.S. - 316	904 L
INLET SCREEN	14.03	S.S. - 304	S.S. - 316	S.S. - 304	S.S. - 316	904 L
PUMP SHAFT	22.00	S.S. - 304 / 431*	S.S. - 316 / 329*	S.S. - 431	S.S. - 329	6"-SI31803 8"&10"-SS329
COUPLING SPLINES	22.01	S.S. - 329	S.S - 329	S.S. - 329	S.S. - 329	6"-SI31803 8"&10"-SS329
LOCKING STRAPS	17.03	S.S. - 304	S.S - 316	S.S. - 304	S.S. - 316	904 L
CABLE GUARD	17.04	S.S. - 304	S.S - 316	S.S. - 304	S.S. - 316	904 L

* Provided only for 4", 14m³/h

** Applicable for 4" - 14m³/h and 6", 8" & 10" pump models.

Note : 4" 1m³/h to 8m³/h pumps are provided with hexagonal shaft and other 4", 6", 8" & 10" pumps are with round shaft.
VITON Components are optional

GENERAL INFORMATION

Exploded View

S4S-1 / S4S-2 / S4S-3 (Below 29 Stages)

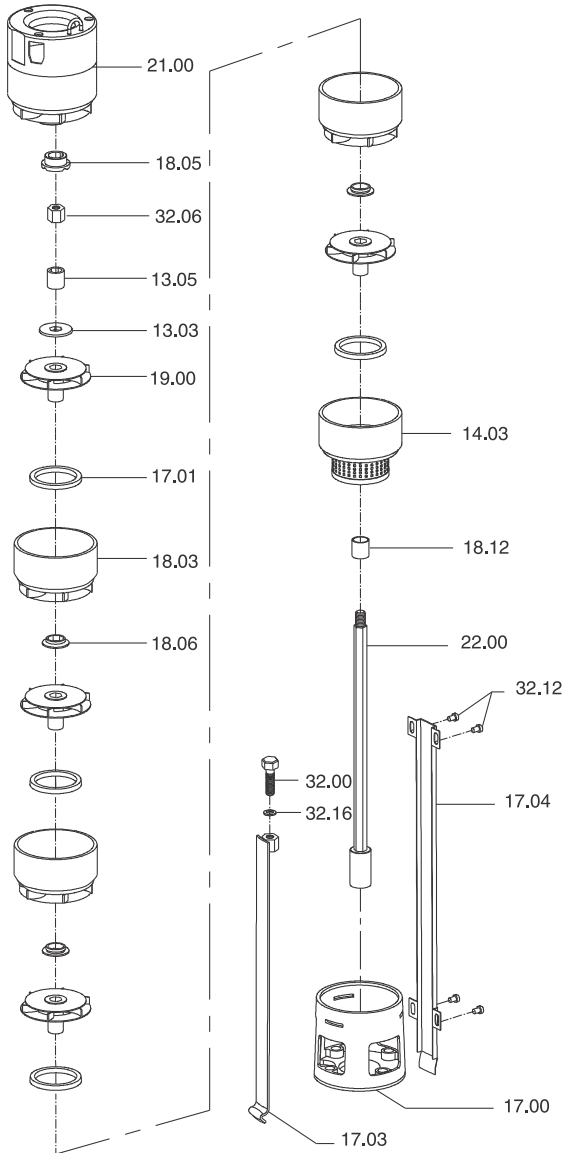

S4S-1 / S4S-2 / S4S-3 (29&above Stages)

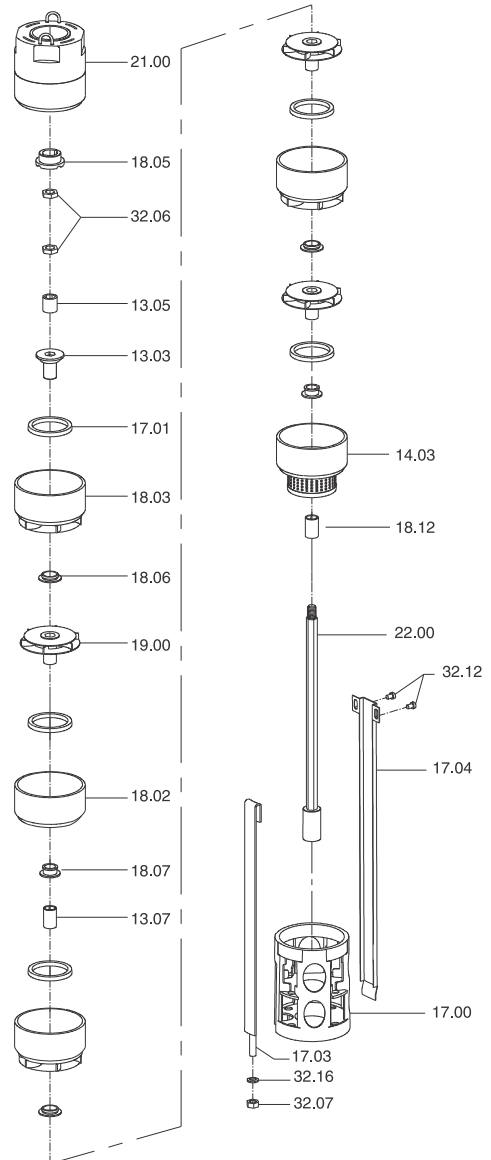

Part No.	Part Name
13.03	Upthrust Washer
13.05	Sleeve
14.03	Chamber-Inlet Screen
17.00	Suction Inter-connector
17.01	Wearing ring
17.03	Locking Straps
17.04	Cable Guard
18.03	Diffuser Chamber
18.05	Bush - CT Pad
18.06	Bush - Diffuser Chamber

Part No.	Part Name
18.12	Spacer Sleeve
19.00	Impeller
21.00	Check Valve Housing
22.00	Pump Shaft
32.00	Bolt
32.06	Lock Nut
32.12	Screw
32.16	Washer

Part No.	Part Name
13.03	Upthrust Sleeve
13.07	Sleeve - Bracket
13.05	Sleeve
14.03	Chamber-Inlet Screen
17.00	Suction Inter-connector
17.01	Wearing ring
17.03	Locking Straps
17.04	Cable Guard
18.02	Chamber - Bracket
18.03	Diffuser Chamber
18.05	Bush - CT Pad

Part No.	Part Name
18.06	Bush - Diffuser Chamber
18.07	Bush - Bracket
18.12	Spacer Sleeve
19.00	Impeller
21.00	Check Valve Housing
22.00	Pump Shaft
32.06	Lock Nut
32.07	Nut
32.12	Screw
32.16	Washer

In view of continuous developments, the informations / descriptions / specifications / illustrations are subject to change without notice. Refer general information for performance curve conditions and for other details. Curve tolerance according to ISO : 9906, Grade 3B

STAINLESS STEEL SERIES

Exploded View

S4S-5 (Below 25 Stages)

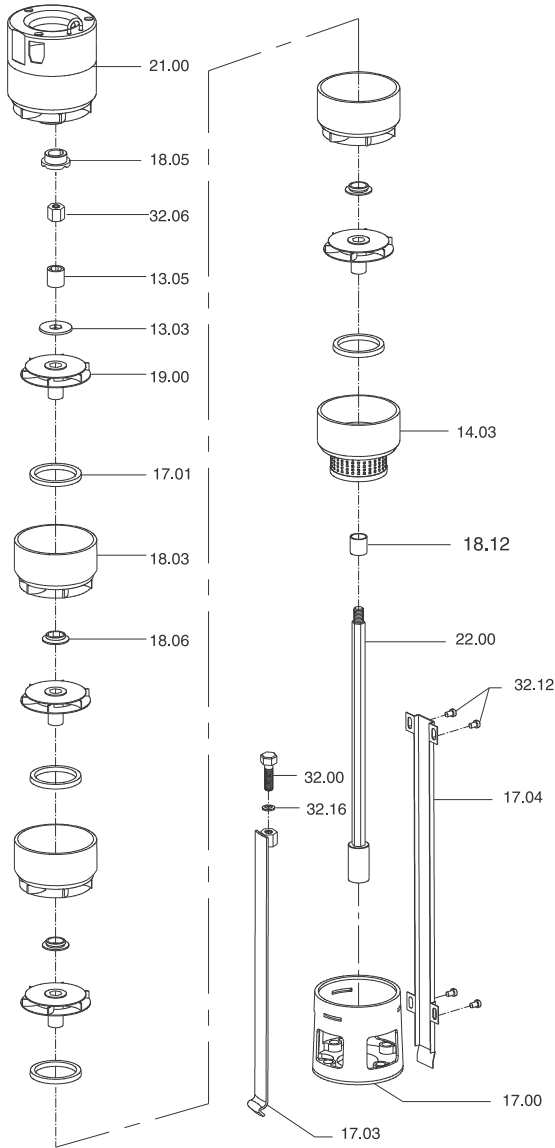

S4S-5 (25 & Above Stages)

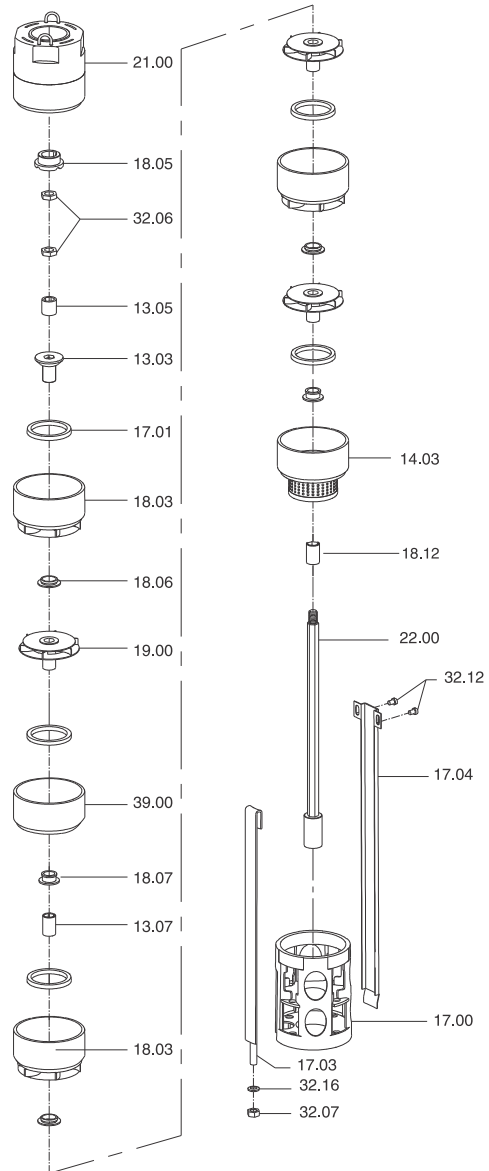

Part No.	Part Name	Part No.	Part Name
13.03	Upthrust Washer	18.12	Spacer Sleeve
13.05	Sleeve	19.00	Impeller
14.03	Chamber-Inlet Screen	21.00	Check Valve Housing
17.00	Suction Inter-connector	22.00	Pump Shaft
17.01	Wearing ring	32.00	Bolt
17.03	Locking Straps	32.06	Lock Nut
17.04	Cable Guard	32.12	Screw
18.03	Diffuser Chamber	32.16	Washer
18.05	Bush - CT Pad		
18.06	Bush - Diffuser Chamber		

Part No.	Part Name	Part No.	Part Name
13.03	Upthrust Sleeve	18.07	Bush - Bracket
13.05	Sleeve	18.12	Spacer Sleeve
13.07	Sleeve-Bracket	19.00	Impeller
14.03	Chamber-Inlet Screen	21.00	Check Valve Housing
17.00	Suction Inter-connector	22.00	Pump Shaft
17.01	Wear ring	32.06	Lock Nut
17.03	Locking Straps	32.07	Nut
17.04	Cable Guard	32.12	Screw
18.03	Diffuser Chamber	32.16	Washer
18.05	Bush - CT Pad	39.00	Chamber - Bracket
18.06	Bush - Diffuser Chamber		

In view of continuous developments, the informations / descriptions / specifications / illustrations are subject to change without notice. Refer general information for performance curve conditions and for other details. Curve tolerance according to ISO : 9906, Grade 3B

GENERAL INFORMATION

Exploded View

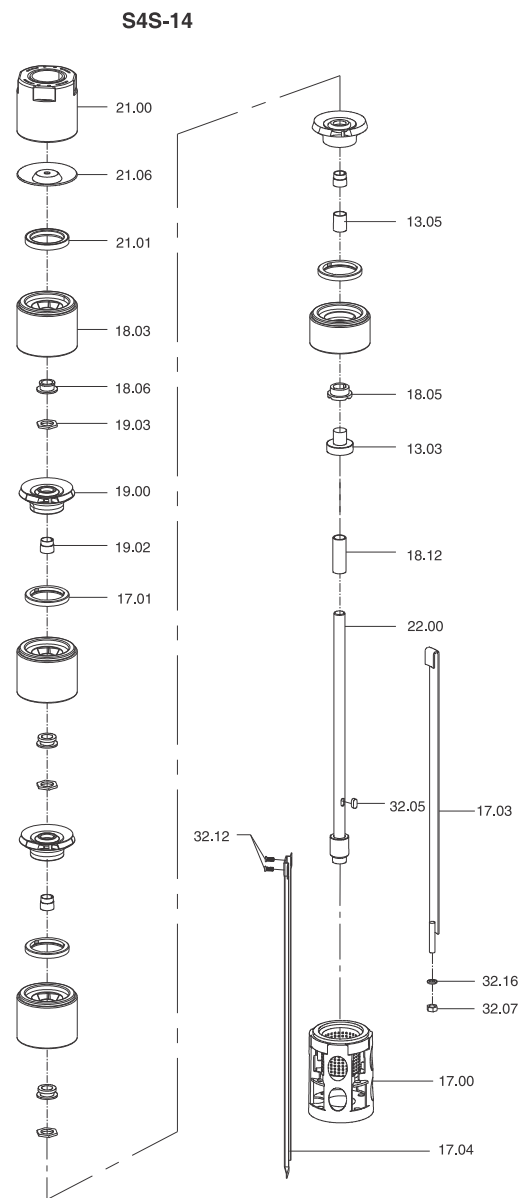
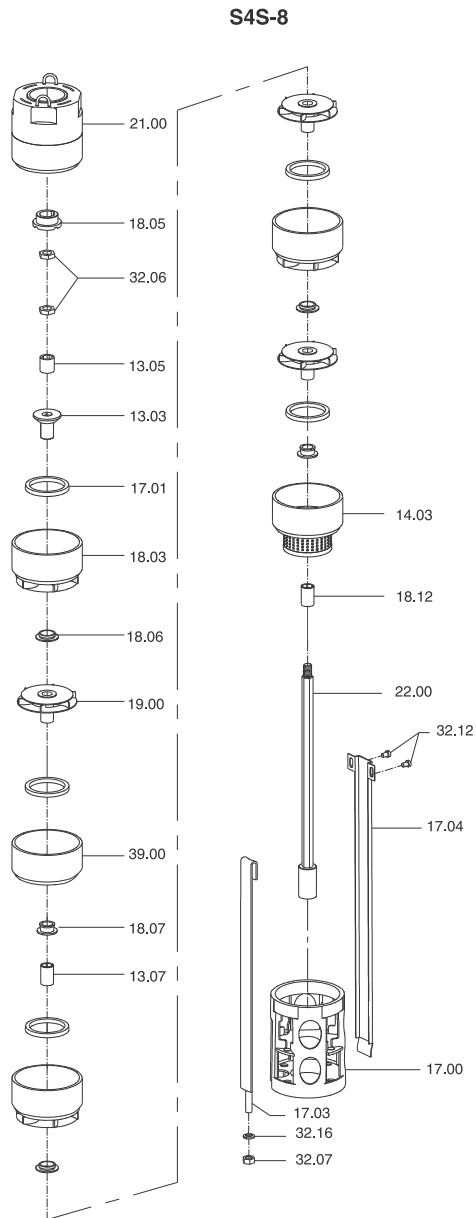

Part No.	Part Name	Part No.	Part Name
13.03	Upthrust Sleeve	18.07	Bush - Bracket
13.05	Sleeve	18.12	Spacer Sleeve
13.07	Sleeve-Bracket	19.00	Impeller
14.03	Chamber-Inlet Screen	21.00	Check Valve Housing
17.00	Suction Inter-connector	22.00	Pump Shaft
17.01	Wear ring	39.00	Chamber - Bracket
17.03	Locking Straps	32.06	Lock Nut
17.04	Cable Guard	32.07	Nut
18.03	Diffuser Chamber	32.12	Screw
18.05	Bush - CT Pad	32.16	Washer
18.06	Bush - Diffuser Chamber		

Part No.	Part Name	Part No.	Part Name
13.03	Upthrust Sleeve	19.02	Split Cone
13.05	Sleeve	19.03	Split Cone Nut
17.00	Suction Inter-connector	21.00	Check Valve Housing
17.01	Wear ring	21.01	Check Valve Seat
17.03	Locking Straps	21.06	Check Valve Disc
17.04	Cable Guard	22.00	Pump Shaft
18.03	Diffuser Chamber	32.05	Key
18.05	Bush - CT Pad	32.07	Nut
18.06	Bush - Diffuser Chamber	32.12	Screw
18.12	Spacer Sleeve	32.16	Washer
19.00	Impeller		

In view of continuous developments, the informations / descriptions / specifications / illustrations are subject to change without notice. Refer general information for performance curve conditions and for other details. Curve tolerance according to ISO : 9906, Grade 3B

STAINLESS STEEL SERIES

Exploded View

S6S-14 / S6S-18 / S6S-22

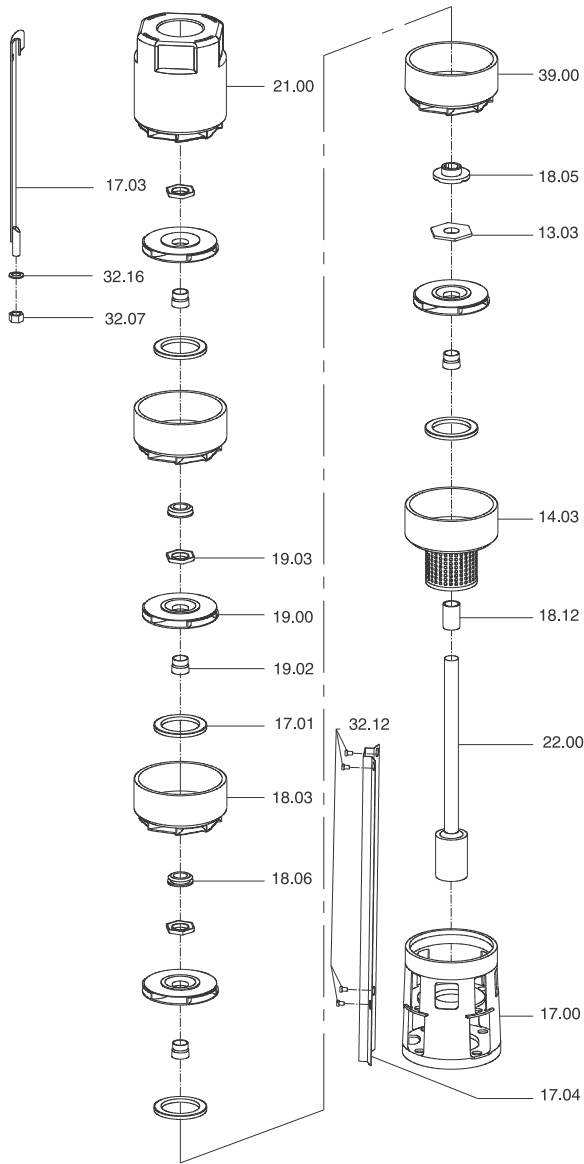

S6S-17

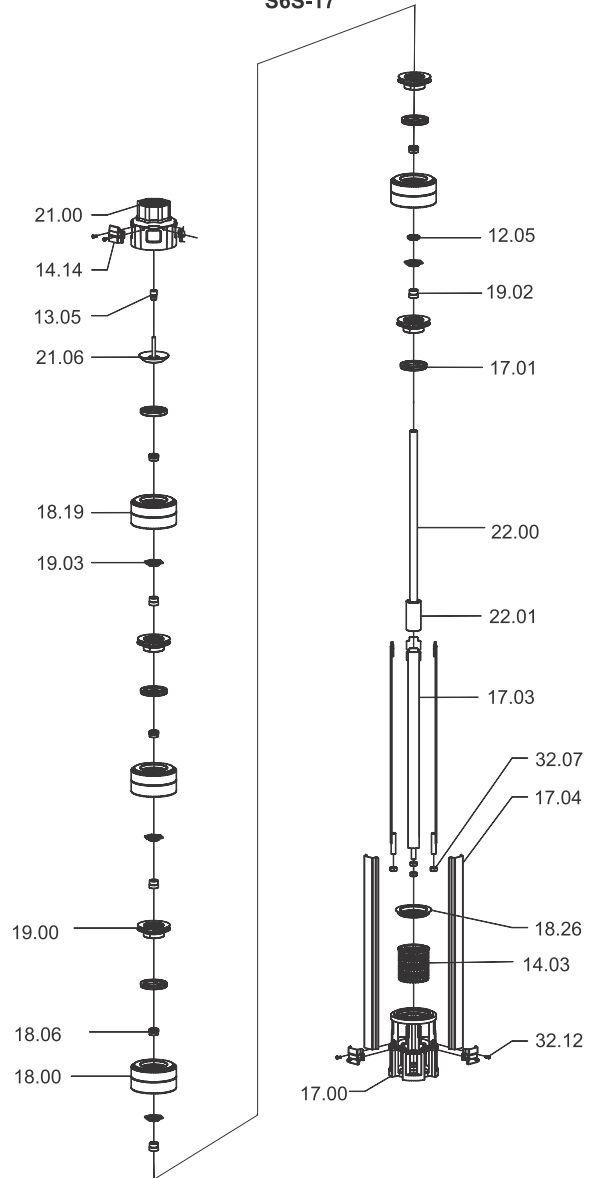

Part No.	Part Name	Part No.	Part Name
13.03	Uphrust Washer	19.03	Split Cone Nut
14.03	Chamber Inlet Screen	21.00	Check Valve Housing
17.00	Suction Inter-connector	22.00	Pump Shaft
17.01	Wear ring	32.07	Nut
17.03	Locking Straps	32.12	Screw
17.04	Cable Guard	32.16	Washer
18.03	Diffuser Chamber	39.00	Chamber - Bracket
18.05	Bush - CT Pad		
18.06	Bush - Diffuser Chamber		
18.12	Spacer Sleeve		
19.00	Impeller		
19.02	Split Cone		

Part No.	Part Name	Part No.	Part Name
12.05	Counter Thrust Ring	18.26	Wearing ring Guide
13.05	Sleeve	19.00	Impeller
14.03	Strainer	19.02	Split Cone
14.14	Cable Clamp	19.03	Split Cone Nut
17.00	Suction Inter Connector	21.00	Valve Housing
17.01	Wear ring	21.06	Valve Disc
17.03	Locking Strap-Pump	22.00	Pump Shaft
17.04	Cable Guard	22.01	Coupling
18.00	Chamber -Rubber bush	22.03	Priming sleeve
18.06	Bush - Rubber	32.06	Lock Nut
18.19	Chamber - Top	32.07	Nut
		32.12	Screw

In view of continuous developments, the informations / descriptions / specifications / illustrations are subject to change without notice. Refer general information for performance curve conditions and for other details. Curve tolerance according to ISO : 9906, Grade 3B

GENERAL INFORMATION

Exploded View

S6S-30 / S6S-48 / S6S-60 / S6S-76 / S6S-92

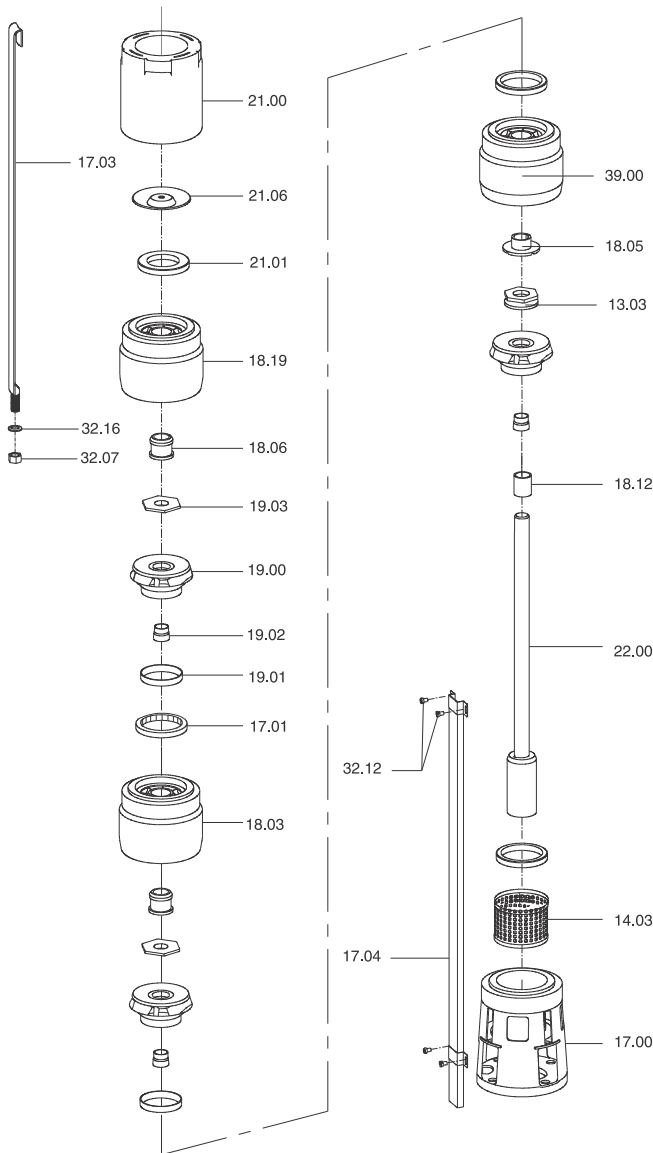

S8S-78 / S8S-95 / S10S-125 / S10S - 160 / S10S-215

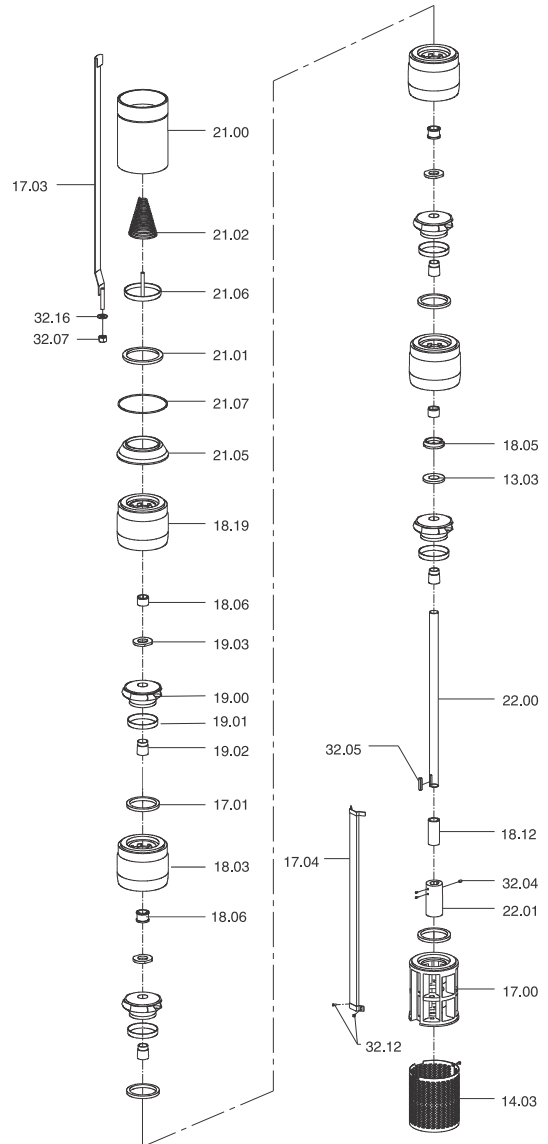

Part No.	Part Name	Part No.	Part Name
13.03	Uphrust Washer	19.01	Neck Ring
14.03	Inlet Screen	19.02	Split Cone
17.00	Suction Inter-connector	19.03	Split Cone Nut
17.01	Wear ring	21.00	Check Valve Housing
17.03	Locking Straps	21.01	Check Valve Seat
17.04	Cable Guard	21.06	Check Valve Disc
18.05	Bush - CT Pad	22.00	Pump Shaft
18.06	Bush - Diffuser Chamber	32.07	Nut
18.03	Diffuser Chamber	32.12	Screw
18.12	Spacer Sleeve	32.16	Washer
18.19	Diffuser Chamber Top	39.00	Chamber - Bracket
19.00	Impeller		

Part No.	Part Name	Part No.	Part Name
13.03	Uphrust Washer	19.03	Split Cone Nut
14.03	Inlet Screen	21.00	Check Valve Housing
17.00	Suction Inter-connector	21.01	Check Valve Seat
17.01	Wear ring	21.02	Check Valve Spring
17.03	Locking Straps	21.05	Check Valve bracket
17.04	Cable Guard	21.06	Check valve Disc
18.03	Diffuser Chamber	21.07	O-Ring
18.05	Bush - CT Pad	22.00	Pump Shaft
18.06	Bush - Diffuser Chamber	22.01	Coupling
18.12	Spacer Sleeve	32.04	Crub Screw
18.19	Diffuser Chamber Top	32.05	Key
19.00	Impeller	32.07	Nut
19.01	Neck Ring	32.12	Screw
19.02	Split Cone	32.16	Washer

In view of continuous developments, the informations / descriptions / specifications / illustrations are subject to change without notice. Refer general information for performance curve conditions and for other details. Curve tolerance according to ISO : 9906, Grade 3B

STAINLESS STEEL SERIES

Nominal Diameter : **4"**

Nominal Flow : **1m³/h**

Outlet Size : **1¼"**

Performance Table

DIMENSIONS & WEIGHT

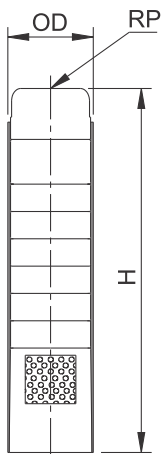

PUMP MODEL	REQUIRED MOTOR POWER		DIMENSIONS (mm)			APPROX NETT. WEIGHT (kg)
	kW	HP	OD	RP	H	
S4S-1/09	0.37	0.5	97	32	357	4
S4S-1/14	0.37	0.5	97	32	467	5
S4S-1/18	0.55	0.75	97	32	555	6
S4S-1/21	0.55	0.75	97	32	621	7
S4S-1/28	0.75	1	97	32	775	9
S4S-1/36	1.1	1.5	97	32	1094	13
S4S-1/42	1.1	1.5	97	32	1262	16
S4S-1/50	1.5	2	97	32	1454	19
S4S-1/57	1.5	2	97	32	1646	21

PUMP MODEL	MOTOR kW	lbs	0	0.11	0.16	0.22	0.27	0.33	0.38	0.44	0.47
		m ³ /h	0	0.40	0.60	0.80	1.0	1.2	1.4	1.6	1.7
S4S-1/09	0.37	TOTAL MANOMETRIC HEAD IN METRES - (COLUMN WATER)	50	45	41	38	32	26.5	20	12	9
S4S-1/14	0.37		80	70.5	65	58	49	39	29	18	12.5
S4S-1/18	0.55		105	94	88	79.5	70	59.5	47	33	26
S4S-1/21	0.55		125	116.5	108.5	99	85	69.5	53	39	30
S4S-1/28	0.75		165	148	135	122.5	107.5	90	69	47	35
S4S-1/36	1.1		198	182	165	145	123	102	80	54	41
S4S-1/42	1.1		230	211	190	165	140	116	89	60	45
S4S-1/50	1.5		280	250	226	199	170	140	106	70	51
S4S-1/57	1.5		320	284	253	221	189	155	120	82	63

In view of continuous developments, the informations / descriptions / specifications / illustrations are subject to change without notice. Refer general information for performance curve conditions and for other details. Curve tolerance according to ISO : 9906, Grade 3B

STAINLESS STEEL SERIES

Nominal Diameter : **4"**

Nominal Flow : **1m³/h**

Outlet Size : **1 1/4"**

Performance Curves

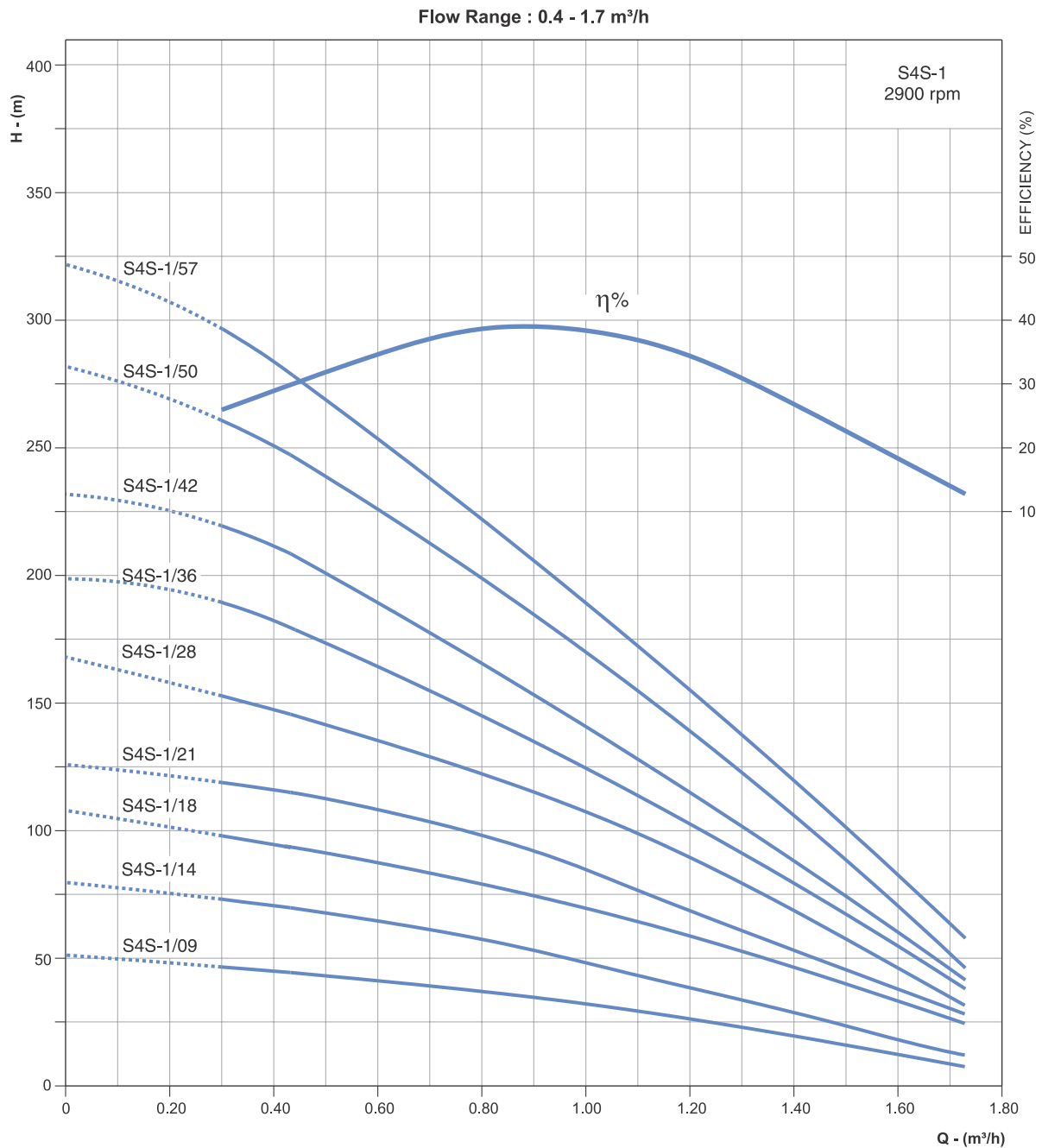

In view of continuous developments, the informations / descriptions / specifications / illustrations are subject to change without notice. Refer general information for performance curve conditions and for other details. Curve tolerance according to ISO : 9906, Grade 3B

STAINLESS STEEL SERIES

Nominal Diameter : **4"**

Nominal Flow : **2m³/h**

Outlet Size : **1 1/4"**

Performance Table

DIMENSIONS & WEIGHT

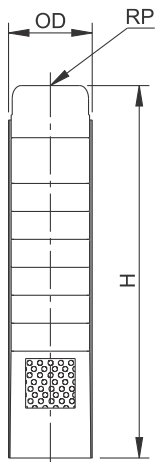

PUMP MODEL	REQUIRED MOTOR POWER		DIMENSIONS (mm)			APPROX NETT. WEIGHT (kg)
	kW	HP	OD	RP	H	
S4S-2/06	0.37	0.5	97	32	291	3
S4S-2/09	0.37	0.5	97	32	357	3
S4S-2/13	0.55	0.75	97	32	445	4
S4S-2/15	0.55	0.75	97	32	489	5
S4S-2/18	0.75	1	97	32	554	6
S4S-2/23	1.1	1.5	97	32	665	7
S4S-2/28	1.5	2	97	32	775	8
S4S-2/33	1.5	2	97	32	1022	12
S4S-2/40	2.2	3	97	32	1214	14
S4S-2/48	2.2	3	97	32	1382	17
S4S-2/55	3	4	97	32	1550	20
S4S-2/65	3	4	97	32	1838	22
S4S-2/75	4	5.5	97	32	2078	26
S4S-2/90	4	5.5	97	32	2438	31

PUMP MODEL	MOTOR kW	ips	0	0.16	0.27	0.38	0.50	0.55	0.61	0.72
		m ³ /h	0	0.6	1.0	1.4	1.8	2.0	2.2	2.5
S4S-2/06	0.37	TOTAL MANOMETRIC HEAD IN METRES - (COLUMN WATER)	35	28	26.5	25	23	20	17	8
S4S-2/09	0.37		54	49	45	40	35	30	25	19
S4S-2/13	0.55		76	72	68	60	48	42	36	27
S4S-2/15	0.55		90	82	78	70	60	57	48	38
S4S-2/18	0.75		120	115	102	92	80	72	63	50
S4S-2/23	1.1		145	140	128	113	93	82	71	57
S4S-2/28	1.5		180	172	160	142	121	110	98	77
S4S-2/33	1.5		215	199	183	165	140	124	108	82
S4S-2/40	2.2		249	232	218	195	165	144	127	92
S4S-2/48	2.2		285	272	254	227	195	174	148	100
S4S-2/55	3		335	306	282	250	209	183	158	110
S4S-2/65	3		405	375	342	301	257	228	196	138
S4S-2/75	4		460	435	403	363	305	272	235	164
S4S-2/90	4		535	513	473	421	358	319	276	198

In view of continuous developments, the informations / descriptions / specifications / illustrations are subject to change without notice. Refer general information for performance curve conditions and for other details. Curve tolerance according to ISO : 9906, Grade 3B

STAINLESS STEEL SERIES

Nominal Diameter : **4"**

Nominal Flow : **2m³/h**

Outlet Size : **1 1/4"**

Performance Curves

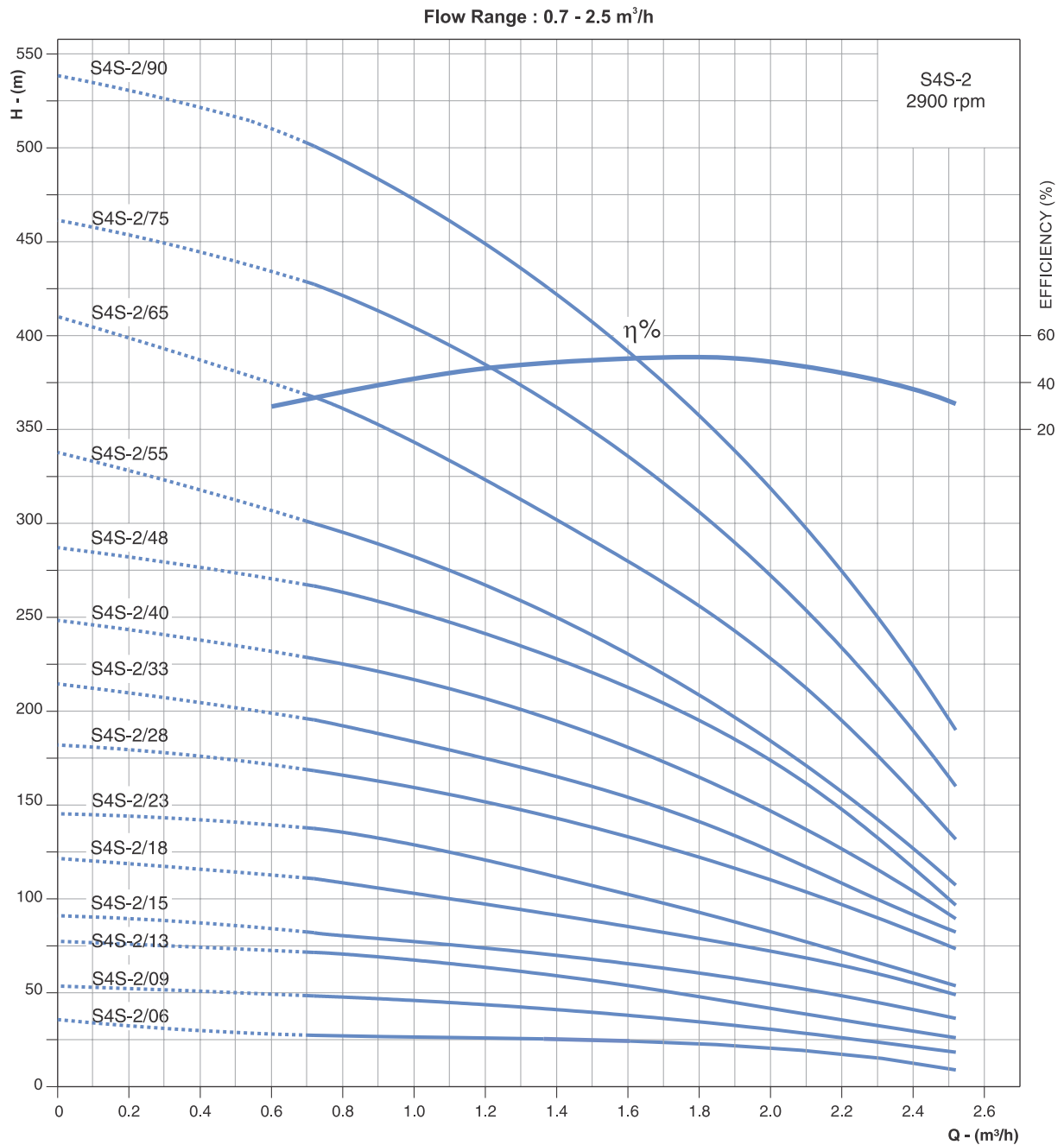

In view of continuous developments, the informations / descriptions / specifications / illustrations are subject to change without notice. Refer general information for performance curve conditions and for other details. Curve tolerance according to ISO : 9906, Grade 3B

STAINLESS STEEL SERIES

Nominal Diameter : **4"**

Nominal Flow : **3m³/h**

Outlet Size : **1 1/4"**

Performance Table

DIMENSIONS & WEIGHT

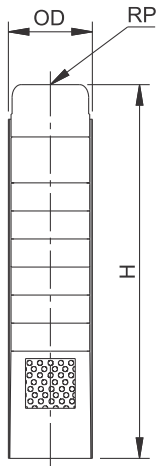

PUMP MODEL	REQUIRED MOTOR POWER		DIMENSIONS (mm)			APPROX NETT. WEIGHT (kg)
	kW	HP	OD	RP	H	
S4S-3/06	0.37	0.5	97	32	291	3
S4S-3/09	0.55	0.75	97	32	357	3
S4S-3/12	0.75	1	97	32	423	4
S4S-3/15	1.1	1.5	97	32	489	5
S4S-3/18	1.1	1.5	97	32	555	6
S4S-3/22	1.5	2	97	32	643	7
S4S-3/25	1.5	2	97	32	709	8
S4S-3/29	2.2	3	97	32	797	8
S4S-3/33	2.2	3	97	32	1022	12
S4S-3/39	3	4	97	32	1166	14
S4S-3/45	3	4	97	32	1334	16
S4S-3/52	4	5.5	97	32	1502	18
S4S-3/60	4	5.5	97	32	1718	21
S4S-3/75	5.5	7.5	97	32	2148	26

PUMP MODEL	MOTOR kW	lps	0	0.41	0.55	0.69	0.83	0.97	1.11	1.25
		m ³ /h	0	1.5	2.0	2.5	3.0	3.5	4.0	4.5
S4S-3/06	0.37	TOTAL MANOMETRIC HEAD IN METRES - (COLUMN WATER)	35	34	31	29	25	20	15	10
S4S-3/09	0.55		56	52	50	45	40	32	24	14
S4S-3/12	0.75		75	67	63	60	53	45	32	19
S4S-3/15	1.1		98	86	82	76	67	55	41	25
S4S-3/18	1.1		115	106	100	91	80	66	50	32
S4S-3/22	1.5		140	129	121	111	99	80	60	35
S4S-3/25	1.5		156	143	135	122	107	89	65	40
S4S-3/29	2.2		185	169	156	144	129	108	80	50
S4S-3/33	2.2		209	190	180	166	149	123	90	57
S4S-3/39	3		245	223	210	195	177	153	117	75
S4S-3/45	3		275	255	243	227	206	176	135	81
S4S-3/52	4		320	295	280	263	240	207	160	97
S4S-3/60	4		377	337	320	300	270	230	180	110
S4S-3/75	5.5		465	415	395	370	332	282	220	132

In view of continuous developments, the informations / descriptions / specifications / illustrations are subject to change without notice. Refer general information for performance curve conditions and for other details. Curve tolerance according to ISO : 9906, Grade 3B

STAINLESS STEEL SERIES

Nominal Diameter : **4"**

Nominal Flow : **3m³/h**

Outlet Size : **1 1/4"**

Performance Curves

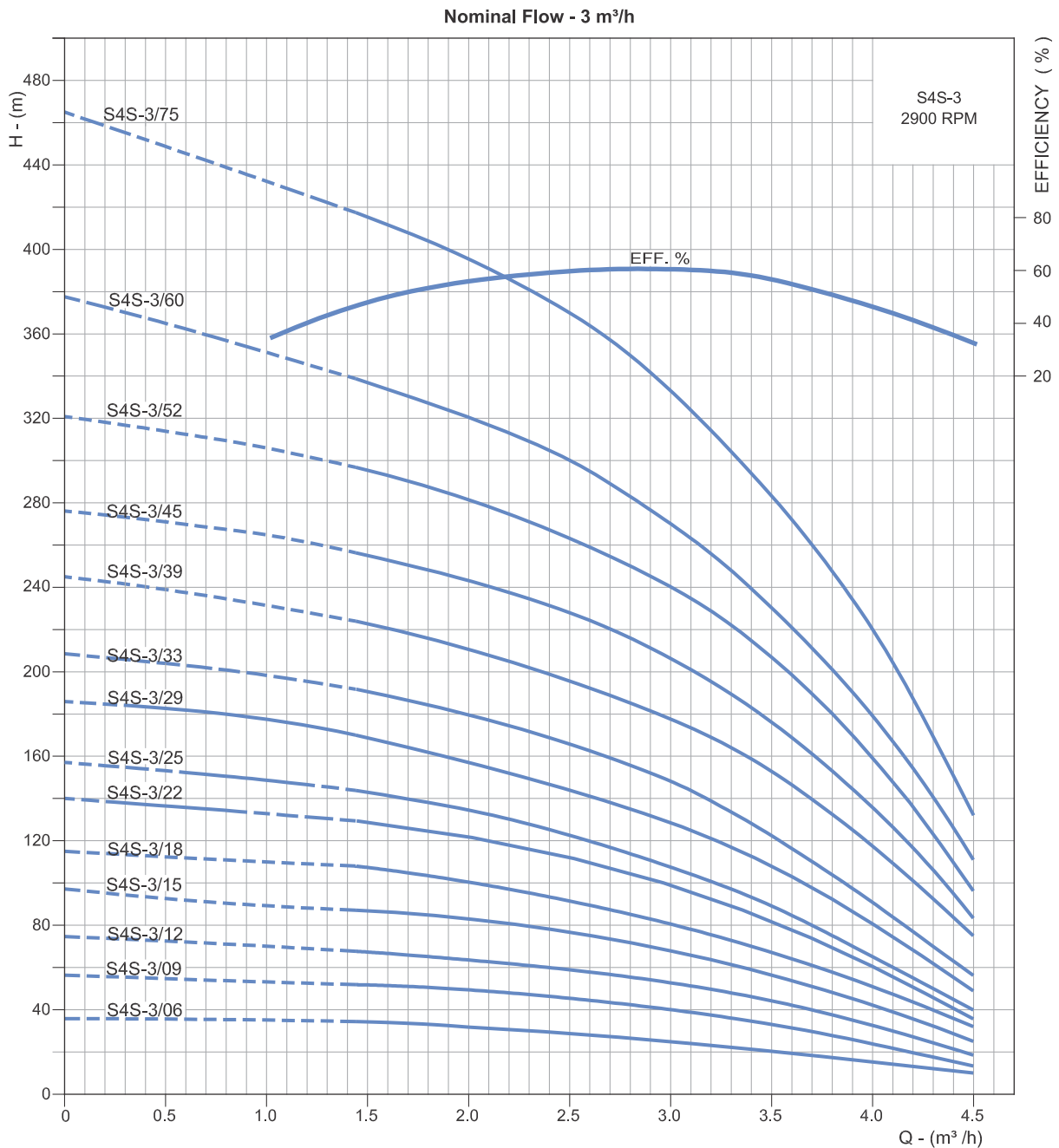

In view of continuous developments, the informations / descriptions / specifications / illustrations are subject to change without notice. Refer general information for performance curve conditions and for other details. Curve tolerance according to ISO : 9906, Grade 3B

STAINLESS STEEL SERIES

Nominal Diameter : **4"**

Nominal Flow : **5m³/h**

Outlet Size : **1½"**

Performance Table

DIMENSIONS & WEIGHT

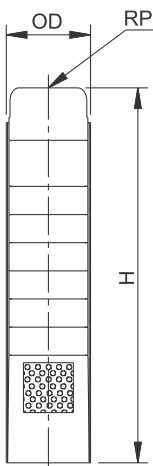

PUMP MODEL	REQUIRED MOTOR POWER		DIMENSIONS (mm)			APPROX NETT. WEIGHT (kg)
	kW	HP	OD	RP	H	
S4S-5/04	0.37	0.5	97	40	255	2
S4S-5/06	0.55	0.75	97	40	303	3
S4S-5/08	0.75	1	97	40	351	4
S4S-5/12	1.1	1.5	97	40	447	5
S4S-5/17	1.5	2	97	40	567	6
S4S-5/21	2.2	3	97	40	663	7
S4S-5/25	2.2	3	97	40	759	8
S4S-5/33	3	4	97	40	1022	12
S4S-5/38	4	5.5	97	40	1142	13
S4S-5/44	4	5.5	97	40	1310	16
S4S-5/52	5.5	7.5	97	40	1502	18
S4S-5/60	5.5	7.5	97	40	1718	21
S4S-5/70	7.5	10	97	40	1939	25
S4S-5/75	7.5	10	97	40	2078	27

PUMP MODEL	MOTOR kW	TOTAL MANOMETRIC HEAD IN METRES - (COLUMN WATER)	lps	0	0.55	0.83	1.11	1.39	1.66	1.94
			m ³ /h	0	2.0	3.0	4.0	5.0	6.0	7.0
S4S-5/04	0.37			28	26	22.5	20	17	12	5
S4S-5/06	0.55		39	36	32	28	22	17	10	
S4S-5/08	0.75		46	42.5	40	37	32	23	15	
S4S-5/12	1.1		75	71	65	57	48	38	24	
S4S-5/17	1.5		108	94	88	80	68	51	33	
S4S-5/21	2.2		138	121	112	99	84	65	42	
S4S-5/25	2.2		162	143	131	119	102	77	53	
S4S-5/33	3		202	179	165	147	128	100	68	
S4S-5/38	4		241	215	198	177	152	119	81	
S4S-5/44	4		280	244	223	199	170	134	92	
S4S-5/52	5.5		324	281	258	230	199	156	108	
S4S-5/60	5.5		360	322	300	262	236	190	130	
S4S-5/70	7.5		440	389	360	325	279	220	152	
S4S-5/75	7.5		487	427	392	352	302	237	168	

In view of continuous developments, the informations / descriptions / specifications / illustrations are subject to change without notice. Refer general information for performance curve conditions and for other details. Curve tolerance according to ISO : 9906, Grade 3B

STAINLESS STEEL SERIES

Nominal Diameter : **4"**

Nominal Flow : **5m³/h**

Outlet Size : **1 1/2"**

Performance Curves

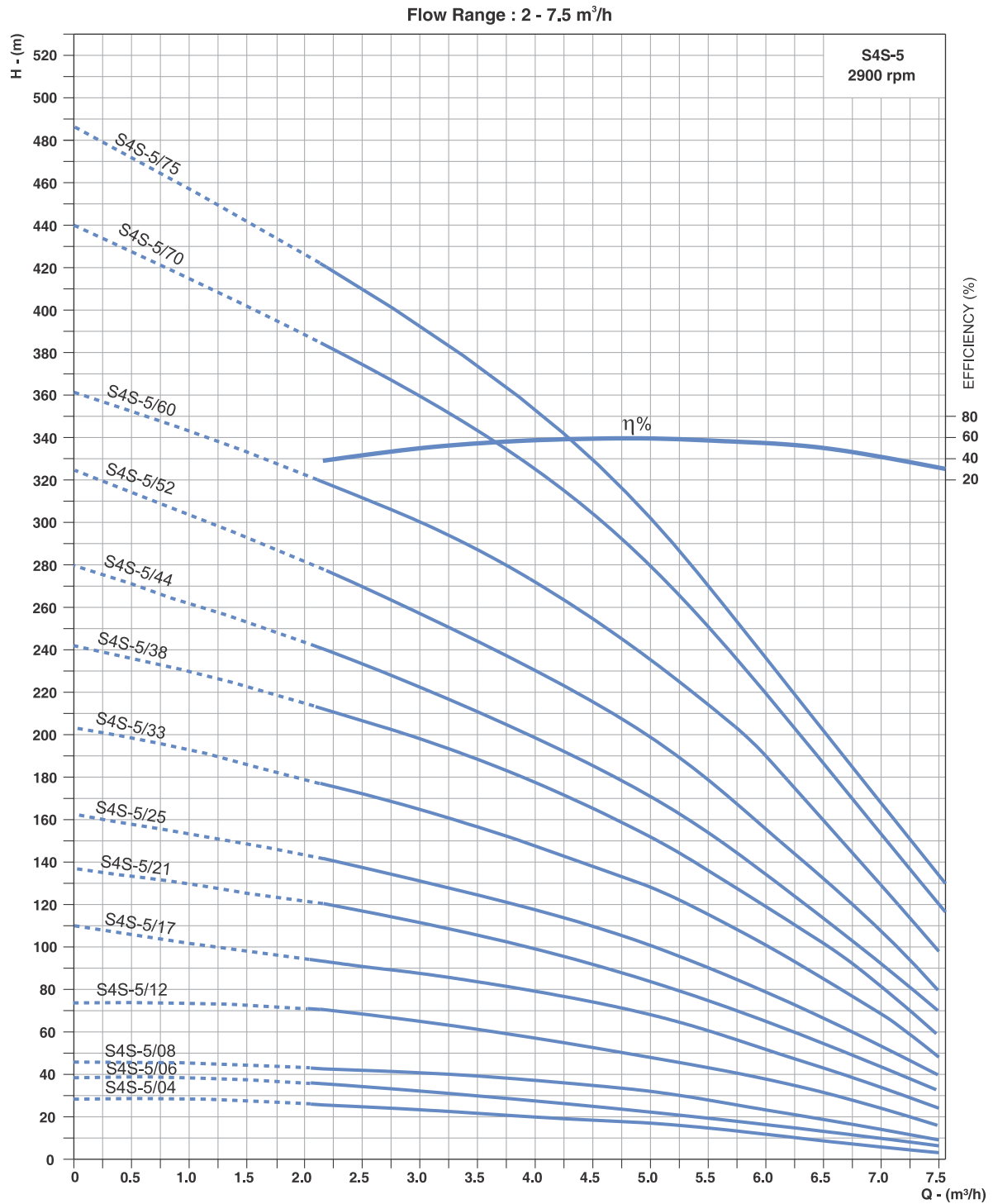

In view of continuous developments, the informations / descriptions / specifications / illustrations are subject to change without notice. Refer general information for performance curve conditions and for other details. Curve tolerance according to ISO : 9906, Grade 3B

STAINLESS STEEL SERIES

Nominal Diameter : **4"**

Nominal Flow : **8m³/h**

Outlet Size : **2"**

Performance Table

DIMENSIONS & WEIGHT

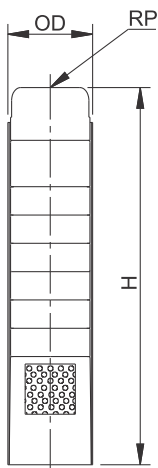

PUMP MODEL	REQUIRED MOTOR POWER		DIMENSIONS (mm)			APPROX NETT. WEIGHT (kg)
	kW	HP	OD	RP	H	
S4S-8/05	0.75	1	97	50	410	5
S4S-8/07	1.1	1.5	97	50	482	5
S4S-8/09	1.5	2	97	50	554	6
S4S-8/10	1.5	2	97	50	590	6
S4S-8/12	2.2	3	97	50	662	7
S4S-8/15	2.2	3	97	50	770	9
S4S-8/18	3	4	97	50	878	10
S4S-8/22	4	5.5	97	50	1022	12
S4S-8/25	4	5.5	97	50	1152	13
S4S-8/30	5.5	7.5	97	50	1332	15
S4S-8/34	5.5	7.5	97	50	1476	17
S4S-8/37	5.5	7.5	97	50	1606	19
S4S-8/44	7.5	10	97	50	1860	22
S4S-8/50	7.5	10	97	50	2076	25
S4S-8/58	9.3	12.5	97	50	2390	30
S4S-8/66	11	15	97	50	2678	35
S4S-8/73	11	15	97	50	2954	39

PUMP MODEL	MOTOR kW	lps m ³ /h	0	0.83	1.11	1.39	1.66	1.94	2.22	2.50	2.78	3.05
			0	3.0	4.0	5.0	6.0	7.0	8.0	9.0	10.0	11.0
S4S-8/05	0.75	TOTAL MANOMETRIC HEAD IN METRES - (COLUMN WATER)	32	27	25	24	22	20	18	16	13.5	11
S4S-8/07	1.1		42	39	37	36	34	32	27	25	20	16
S4S-8/09	1.5		55	50	49	46	44	42	38	34	28	22
S4S-8/10	1.5		63	55	52	50	48	44	40	36	30	24
S4S-8/12	2.2		74	69	67	64	61	56	51	45	37	27.5
S4S-8/15	2.2		94	86	83	79	75	69	63	55	28	36
S4S-8/18	3		108	105	101	96	91	84	76	67	56	44
S4S-8/22	4		132	126	121	115	108	99	90	79	67	54
S4S-8/25	4		155	141	136	129	122	112	103	91	78	62
S4S-8/30	5.5		182	164	156	148	139	130	120	107	90	71
S4S-8/34	5.5		202	185	179	171	163	153	140	126	107	85
S4S-8/37	5.5		230	204	195	185	173	162	146	131	112	89
S4S-8/44	7.5		262	237	228	217	205	191	177	156	129	100
S4S-8/50	7.5		304	272	261	249	235	220	200	176	148	112
S4S-8/58	9.3		339	300	284	270	255	241	225	198	162	127
S4S-8/66	11		378	340	323	310	295	280	260	230	190	149
S4S-8/73	11		422	370	352	338	320	305	282	250	209	161

In view of continuous developments, the informations / descriptions / specifications / illustrations are subject to change without notice. Refer general information for performance curve conditions and for other details. Curve tolerance according to ISO : 9906, Grade 3B

STAINLESS STEEL SERIES

Nominal Diameter : **4"**

Nominal Flow : **8m³/h**

Outlet Size : **2"**

Performance Curves

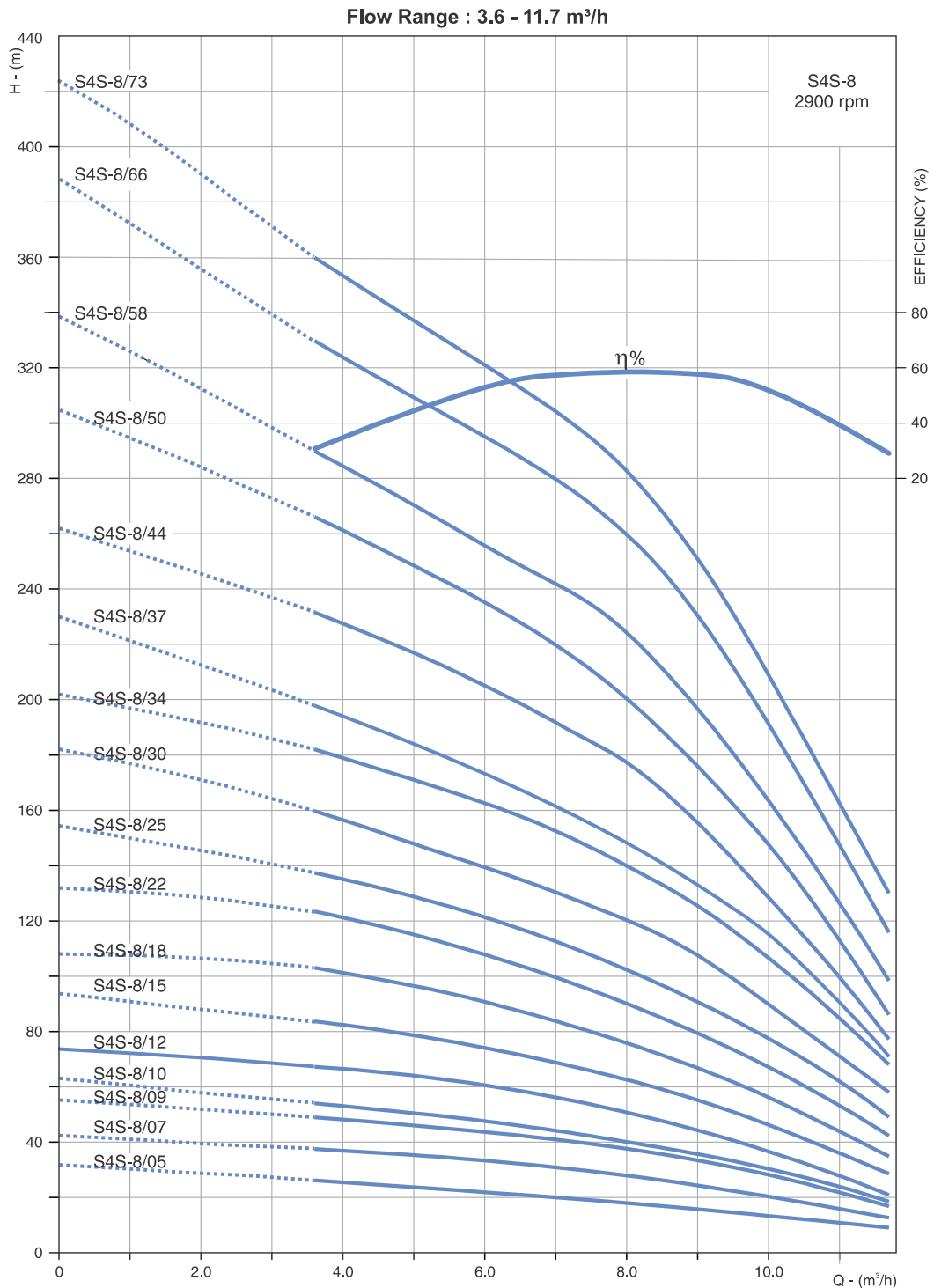

In view of continuous developments, the informations / descriptions / specifications / illustrations are subject to change without notice. Refer general information for performance curve conditions and for other details. Curve tolerance according to ISO : 9906, Grade 3B

STAINLESS STEEL SERIES

Nominal Diameter : **4"**

Nominal Flow : **14m³/h**

Outlet Size : **2"**

Performance Table

DIMENSIONS & WEIGHT

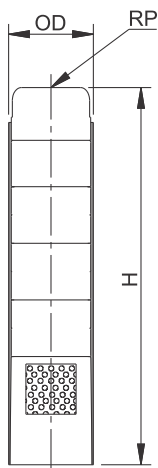

PUMP MODEL	REQUIRED MOTOR POWER		DIMENSIONS (mm)			APPROX NETT. WEIGHT (kg)
	kW	HP	OD	RP	H	
S4S-14/05	1.5	2	97	50	573	6
S4S-14/07	2.2	3	97	50	703	8
S4S-14/09	3	4	97	50	833	9
S4S-14/10	3	4	97	50	898	10
S4S-14/11	3.7	5	97	50	963	10
S4S-14/13	4	5.5	97	50	1093	12
S4S-14/16	5.5	7.5	97	50	1288	14
S4S-14/18	5.5	7.5	97	50	1418	16
S4S-14/22	7.5	10	97	50	1678	19
S4S-14/25	7.5	10	97	50	1873	21

PUMP MODEL	MOTOR kW	lps	0	1.11	1.67	2.22	2.78	3.33	3.89	4.44	5.00
		m ³ /h	0	4	6	8	10	12	14	16	18
TOTAL MANOMETRIC HEAD IN METRES - (COLUMN WATER)	S4S-14/05	1.5	31	30	29	28	26	23	20	16	12
	S4S-14/07	2.2	42	41	40	39	37	33	29	24	15
	S4S-14/09	3	56	55	53	51	47	43	38	32	25
	S4S-14/10	3	65	63	60	57	54	49	43	37	29
	S4S-14/11	3.7	75	72	70	66	62	56	50	42	32
	S4S-14/13	4	85	83	80	75	70	64	56	47	36
	S4S-14/16	5.5	104	102	99	95	89	81	71	59	44
	S4S-14/18	5.5	119	115	112	107	100	91	81	56	50
	S4S-14/22	7.5	141	136	132	127	120	111	96	78	58
	S4S-14/25	7.5	161	156	152	145	137	125	110	91	68

In view of continuous developments, the informations / descriptions / specifications / illustrations are subject to change without notice. Refer general information for performance curve conditions and for other details. Curve tolerance according to ISO : 9906, Grade 3B

STAINLESS STEEL SERIES

Nominal Diameter : **4"**

Nominal Flow : **14m³/h**

Outlet Size : **2"**

Performance Curves

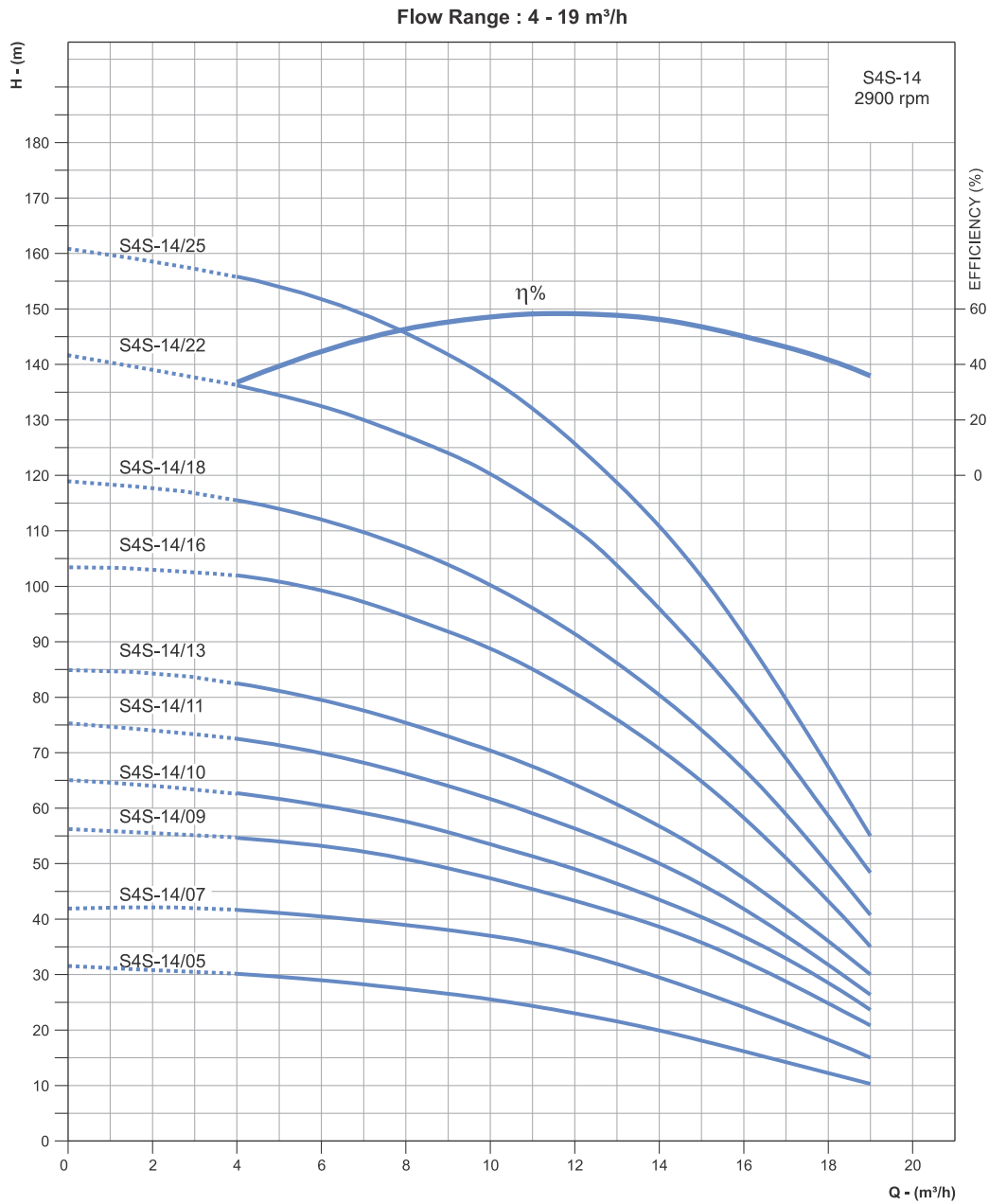

In view of continuous developments, the informations / descriptions / specifications / illustrations are subject to change without notice. Refer general information for performance curve conditions and for other details. Curve tolerance according to ISO : 9906, Grade 3B

STAINLESS STEEL SERIES

Nominal Diameter : **6"**

Nominal Flow : **14m³/h**

Outlet Size : **2"/2½"****

Performance Table

DIMENSIONS & WEIGHT

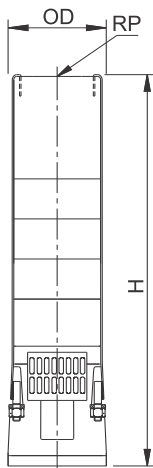

PUMP MODEL	REQUIRED MOTOR POWER		*NO OF CABLE GUARD	DIMENSIONS (mm)			APPROX NETT. WEIGHT (kg)
	kW	HP		OD	RP	H	
S6S-14/05	3	4	1	139	50/65	491	12
S6S-14/06	3	4	1	139	50/65	530	12
S6S-14/07	3.7	5	1	139	50/65	569	13
S6S-14/08	4	5.5	1	139	50/65	608	14
S6S-14/09	5.5	7.5	1	139	50/65	647	15
S6S-14/10	5.5	7.5	1/2	139/143	50/65	686	16
S6S-14/11	5.5	7.5	1/2	139/143	50/65	725	17
S6S-14/12	7.5	10	1/2	139/143	50/65	764	18
S6S-14/13	7.5	10	1/2	139/143	50/65	803	19
S6S-14/14	7.5	10	1/2	139/143	50/65	842	20
S6S-14/15	7.5	10	1/2	139/143	50/65	881	21
S6S-14/16	9.3	12.5	1/2	139/143	50/65	920	22
S6S-14/17	9.3	12.5	1/2	139/143	50/65	959	23
S6S-14/18	9.3	12.5	1/2	139/143	50/65	998	24
S6S-14/19	9.3	12.5	1/2	139/143	50/65	1037	25
S6S-14/20	11	15	1/2	139/143	50/65	1076	25
S6S-14/21	11	15	1/2	139/143	50/65	1115	26
S6S-14/22	11	15	1/2	139/143	50/65	1154	27
S6S-14/23	11	15	1/2	139/143	50/65	1193	28
S6S-14/24	11	15	1/2	139/143	50/65	1232	29
S6S-14/25	13	17.5	1/2	139/143	50/65	1271	30
S6S-14/26	13	17.5	1/2	139/143	50/65	1310	31
S6S-14/27	13	17.5	1/2	139/143	50/65	1349	32
S6S-14/28	13	17.5	1/2	139/143	50/65	1388	33
S6S-14/29	13	17.5	1/2	139/143	50/65	1427	34
S6S-14/30	15	20	1/2	139/143	50/65	1466	35
S6S-14/31	15	20	1/2	139/143	50/65	1505	36
S6S-14/32	15	20	1/2	139/143	50/65	1544	36
S6S-14/33	15	20	1/2	139/143	50/65	1583	37
S6S-14/34	18.5	25	1/2	139/143	50/65	1622	38
S6S-14/35	18.5	25	1/2	139/143	50/65	1661	39
S6S-14/36	18.5	25	1/2	139/143	50/65	1700	40
S6S-14/37	18.5	25	1/2	139/143	50/65	1739	41
S6S-14/38	18.5	25	1/2	139/143	50/65	1778	42
S6S-14/39	18.5	25	1/2	139/143	50/65	1817	43
S6S-14/40	18.5	25	1/2	139/143	50/65	1856	44
S6S-14/41	18.5	25	1/2	139/143	50/65	1895	45
S6S-14/42	18.5	25	1/2	139/143	50/65	1934	46
S6S-14/43	22	30	1/2	139/143	50/65	1973	46
S6S-14/44	22	30	1/2	139/143	50/65	2012	47
S6S-14/45	22	30	1/2	139/143	50/65	2051	48
S6S-14/46	22	30	1/2	139/143	50/65	2090	49
S6S-14/47	22	30	1/2	139/143	50/65	2129	50
S6S-14/48	22	30	1/2	139/143	50/65	2168	51
S6S-14/49	22	30	1/2	139/143	50/65	2207	52
S6S-14/50	22	30	1/2	139/143	50/65	2246	53
S6S-14/54	26	35	1/2	139/143	65	2402	57
S6S-14/64	45	60	1/2	139/143	65	2792	69
S6S-14/65	45	60	1/2	139/143	65	2836	70.48

* 1 denotes Single Cable Guard (D.O.L - 3 wire) and 2 denotes Double Cable Guard (S.D - 6 wire). Please specify preference, while placing order.

** Optional outlet Size.

In view of continuous developments, the informations / descriptions / specifications / illustrations are subject to change without notice. Refer general information for performance curve conditions and for other details. Curve tolerance according to ISO : 9906, Grade 3B

STAINLESS STEEL SERIES

Nominal Diameter : **6"**Nominal Flow : **14m³/h**Outlet Size : **2"/2½****

Performance Table

PUMP MODEL	MOTOR kW	lps	0	1.66	2.22	2.78	3.33	3.89	4.44	5.00
		m ³ /h	0	6	8	10	12	14	16	18
S6S-14/05	3	TOTAL MANOMETRIC HEAD IN METRES - (COLUMN WATER)	59	52	50	46	42	35	26	17
S6S-14/06	3		70	64	60	56	52	44	33	22
S6S-14/07	3.7		82	74	71	67	60	52	40	28
S6S-14/08	4		94	84	80	75	68	59	45	31
S6S-14/09	5.5		104	93	90	84	77	66	50	33
S6S-14/10	5.5		118	104	100	94	85	72	56	36
S6S-14/11	5.5		130	115	108	102	92	79	60	38
S6S-14/12	7.5		140	123	116	109	99	84	64	42
S6S-14/13	7.5		150	130	124	116	107	88	68	46
S6S-14/14	7.5		160	142	135	127	116	99	78	53
S6S-14/15	7.5		172	153	146	137	127	109	87	60
S6S-14/16	9.3		184	164	156	147	135	116	92	64
S6S-14/17	9.3		196	174	166	156	143	123	96	67
S6S-14/18	9.3		204	184	176	166	150	128	100	71
S6S-14/19	9.3		218	189	184	172	156	135	107	75
S6S-14/20	11		228	202	191	179	163	140	112	79
S6S-14/21	11		240	209	197	184	168	147	116	83
S6S-14/22	11		254	219	205	192	176	153	121	90
S6S-14/23	11		262	236	217	204	186	163	129	96
S6S-14/24	11		280	244	232	217	199	172	136	96
S6S-14/25	13		290	257	244	230	211	183	144	100
S6S-14/26	13		302	267	254	239	220	190	150	104
S6S-14/27	13		316	278	265	248	228	197	156	110
S6S-14/28	13		324	290	276	260	237	204	161	116
S6S-14/29	13		338	300	285	268	244	212	168	118
S6S-14/30	15		350	308	292	275	252	218	172	120
S6S-14/31	15		360	320	304	284	260	227	180	127
S6S-14/32	15		374	332	316	296	272	236	189	132
S6S-14/33	15		384	343	330	310	282	242	192	138
S6S-14/34	18.5		396	356	340	320	292	251	200	145
S6S-14/35	18.5		408	367	349	329	300	259	208	154
S6S-14/36	18.5		420	376	359	337	308	267	216	160
S6S-14/37	18.5		430	385	368	347	316	275	222	167
S6S-14/38	18.5		440	395	376	355	324	281	229	172
S6S-14/39	18.5		454	404	386	363	332	289	237	180
S6S-14/40	18.5		464	412	395	372	340	298	244	188
S6S-14/41	18.5		476	422	404	382	348	305	253	195
S6S-14/42	18.5		488	432	413	391	359	313	260	203
S6S-14/43	22		500	443	424	400	368	320	268	212
S6S-14/44	22		510	453	434	411	376	329	276	220
S6S-14/45	22		520	464	444	420	386	340	284	230
S6S-14/46	22		528	474	455	432	396	348	292	238
S6S-14/47	22		538	483	463	440	405	358	302	244
S6S-14/48	22		550	491	471	448	416	368	312	252
S6S-14/49	22		560	501	481	458	424	380	322	260
S6S-14/50	22	566	512	491	468	435	389	333	268	
S6S-14/54	26	620	552	515	494	455	408	350	280	
S6S-14/64	37	740	665	628	585	535	476	400	312	
S6S-14/65	45	755	670	634	590	540	480	417	318	

** Optional outlet Size.

In view of continuous developments, the informations / descriptions / specifications / illustrations are subject to change without notice.
Refer general information for performance curve conditions and for other details. Curve tolerance according to ISO : 9906, Grade 3B

STAINLESS STEEL SERIES

Nominal Diameter : **6"**

Nominal Flow : **14m³/h**

Outlet Size : **2"/2½"*****

Performance Curves

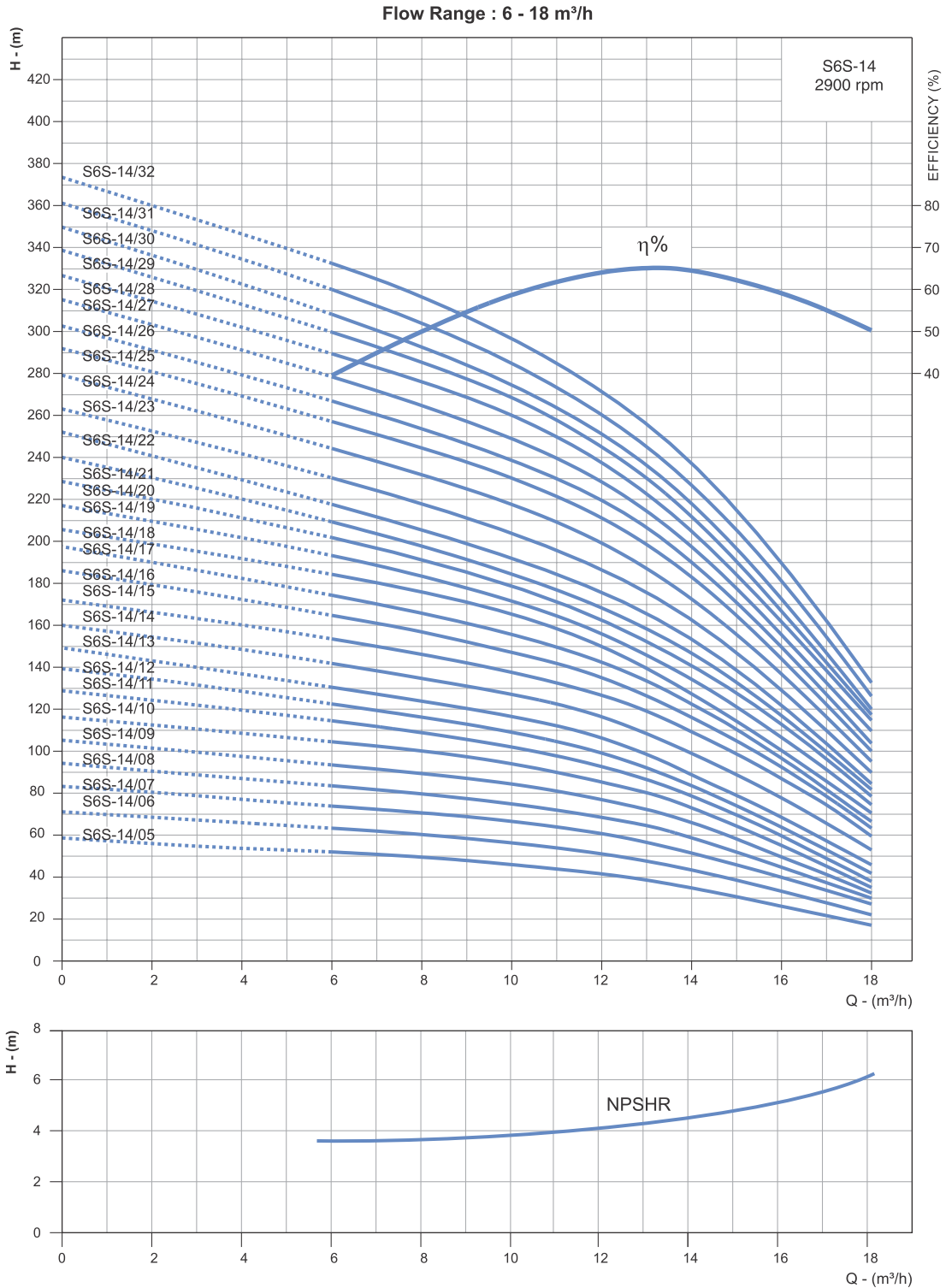

** Optional outlet Size.

In view of continuous developments, the informations / descriptions / specifications / illustrations are subject to change without notice. Refer general information for performance curve conditions and for other details. Curve tolerance according to ISO : 9906, Grade 3B

STAINLESS STEEL SERIES

Nominal Diameter : **6"**

Nominal Flow : **14m³/h**

Outlet Size : **2"/2½"*****

Performance Curves

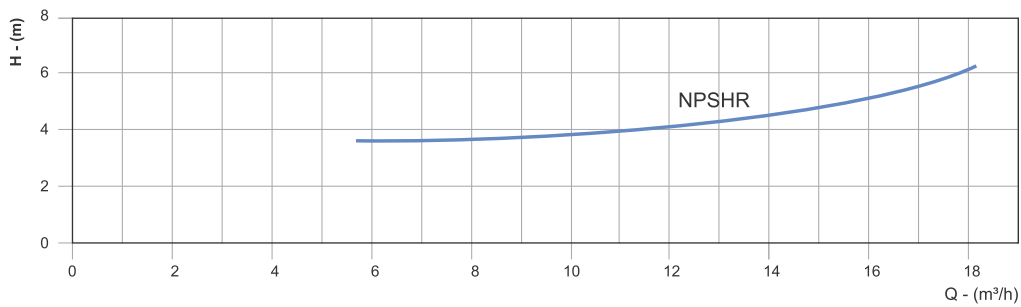
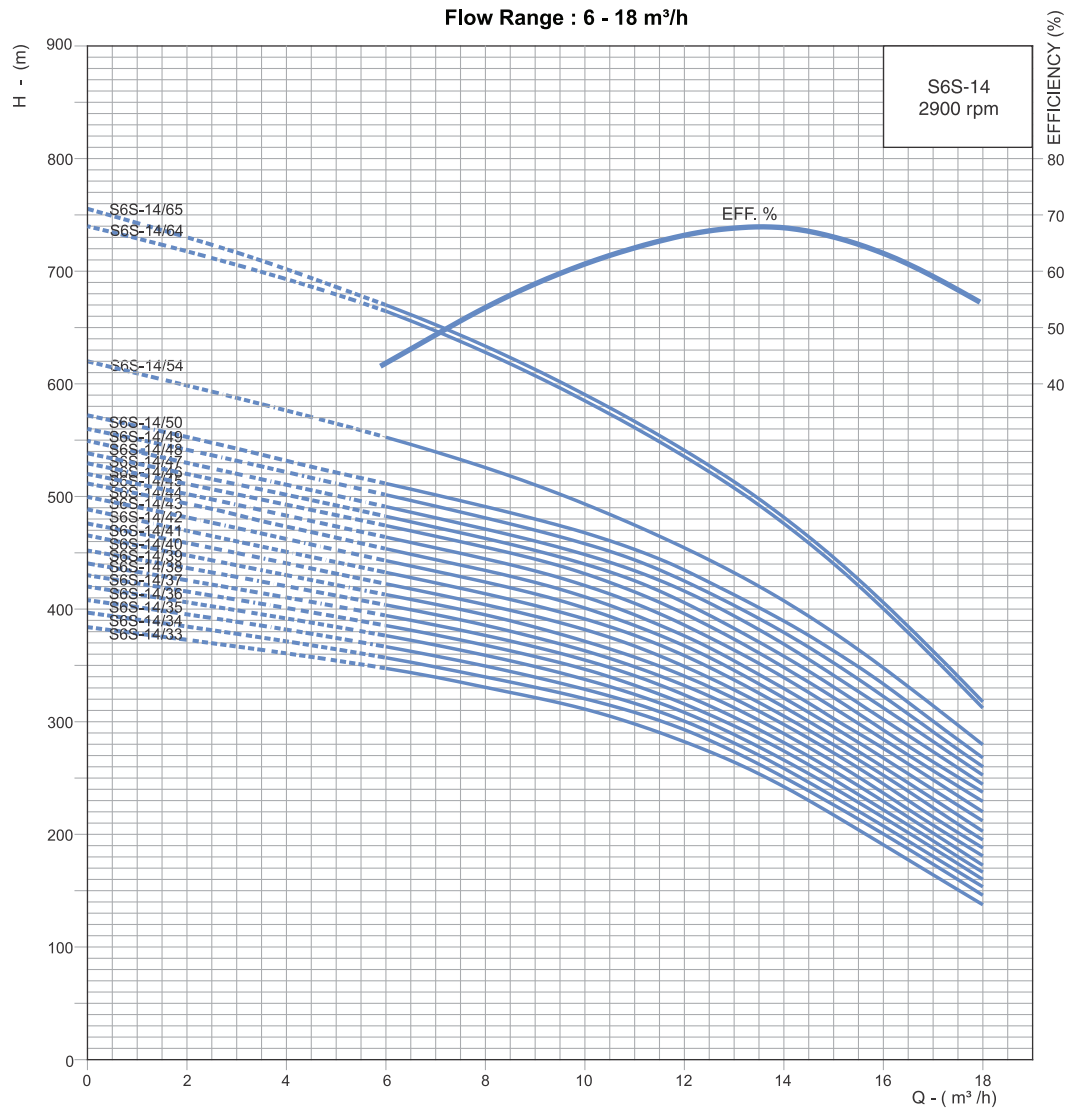

** Optional outlet Size.

In view of continuous developments, the informations / descriptions / specifications / illustrations are subject to change without notice. Refer general information for performance curve conditions and for other details. Curve tolerance according to ISO : 9906, Grade 3B

STAINLESS STEEL SERIES

Nominal Diameter : **6"**

Nominal Flow : **17m³/h**

Outlet Size : **2½"/3"*****

Performance Table

DIMENSIONS & WEIGHT

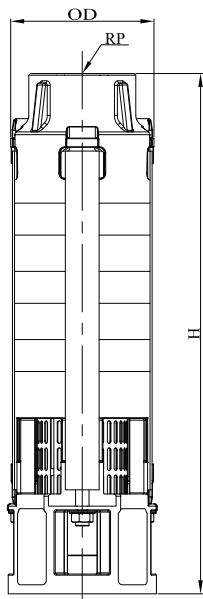

PUMP MODEL	REQUIRED MOTOR POWER		*NO OF CABLE GUARD	DIMENSIONS (mm)			APPROX NETT. WEIGHT (kg)
	kW	HP		OD	RP	H	
S6S-17/1	0.55	1	1	134	65	342	7
S6S-17/2	1.1	1.5	1	134	65	403	8
S6S-17/3	2.2	3	1	134	65	463	9
S6S-17/4	2.2	3	1	134	65	526	11
S6S-17/5	3	4.5.5	1	134	65	584	12
S6S-17/6	4	5.5	1	134	65	645	14
S6S-17/7	4	7.5	1	134	65	705	15
S6S-17/8	5.5	7.5	1	134	65	766	16
S6S-17/9	5.5	7.5	1	134	65	826	18
S6S-17/10	5.5	10	1	134	65	887	19
S6S-17/11	7.5	10	1	134	65	947	20
S6S-17/12	7.5	10	1	134	65	1008	22
S6S-17/13	7.5	5.5	1	134	65	1068	23
S6S-17/7	4	7.5	1/2	142/144	65	705	16
S6S-17/8	5.5	7.5	1/2	142/144	65	766	18
S6S-17/9	5.5	7.5	1/2	142/144	65	826	19
S6S-17/10	5.5	10	1/2	142/144	65	887	20
S6S-17/11	7.5	10	1/2	142/144	65	947	22
S6S-17/12	7.5	10	1/2	142/144	65	1008	23
S6S-17/13	7.5	12.5	1/2	142/144	65	1068	25
S6S-17/14	9.3	12.5	1/2	142/144	65	1129	26
S6S-17/15	9.3	12.5	1/2	142/144	65	1189	27
S6S-17/16	9.3	12.5	1/2	142/144	65	1250	29
S6S-17/17	9.3	15	1/2	142/144	65	1310	30
S6S-17/18	11	15	1/2	142/144	65	1371	32
S6S-17/19	11	15	1/2	142/144	65	1431	33
S6S-17/20	11	17.5	1/2	142/144	65	1492	34
S6S-17/21	13	17.5	1/2	142/144	65	1552	36
S6S-17/22	13	17.5	1/2	142/144	65	1613	37
S6S-17/23	13	17.5	1/2	142/144	65	1673	39
S6S-17/24	13	20	1/2	142/144	65	1734	40
S6S-17/25	15	20	1/2	142/144	65	1794	41
S6S-17/26	15	20	1/2	142/144	65	1855	43
S6S-17/27	15	25	1/2	142/144	65	1915	44
S6S-17/28	18.5	25	1/2	142/144	65	1976	46
S6S-17/29	18.5	25	1/2	142/144	65	2036	47
S6S-17/30	18.5	25	1/2	142/144	65	2097	48
S6S-17/31	18.5	25	1/2	142/144	65	2157	50
S6S-17/32	18.5	25	1/2	142/144	65	2218	51
S6S-17/33	18.5	30	1/2	142/144	65	2278	53
S6S-17/34	22	30	1/2	142/144	65	2339	54
S6S-17/35	22	30	1/2	142/144	65	2399	55
S6S-17/36	22	30	1/2	142/144	65	2460	57
S6S-17/37	22	30	1/2	142/144	65	2520	58
S6S-17/38	22	30	1/2	142/144	65	2581	60
S6S-17/39	22	30	1/2	142/144	65	2641	61
S6S-17/40	22	30	1/2	142/144	65	2702	62

* 1 denotes Single Cable Guard (D.O.L - 3 wire) and 2 denotes Double Cable Guard (S.D - 6 wire). Please specify preference, while placing order.

* OD for 4/6 combination is 134 mm (single cable guard)

** Optional outlet Size.

In view of continuous developments, the informations / descriptions / specifications / illustrations are subject to change without notice. Refer general information for performance curve conditions and for other details. Curve tolerance according to ISO : 9906, Grade 3B

STAINLESS STEEL SERIES

Nominal Diameter : **6"**Nominal Flow : **17m³/h**Outlet Size : **2½"/3" ****

Performance Table

PUMP MODEL	MOTOR kW	lps	0	1.1	1.66	2.78	3.89	4.27	5.55	7.22
		m ³ /h	0	4	6	10	14	17	20	22
S6S-17/1	0.55	TOTAL MANOMETRIC HEAD IN METRES - (COLUMN WATER)	11	11	11	10	8	6	5	4
S6S-17/2	1.1		22	22	21	19	17	14	11	9
S6S-17/3	2.2		33	33	33	30	27	23	18	15
S6S-17/4	2.2		43	43	43	40	35	30	24	18
S6S-17/5	3		54	54	53	50	44	38	30	24
S6S-17/6	4		66	65	64	60	53	47	37	30
S6S-17/7	4		76	76	75	70	62	53	43	34
S6S-17/8	5.5		87	87	86	81	72	62	50	41
S6S-17/9	5.5		98	98	97	91	81	70	56	45
S6S-17/10	5.5		108	108	107	101	88	77	61	49
S6S-17/11	7.5		120	119	118	112	99	86	70	56
S6S-17/12	7.5		130	129	128	121	108	93	75	60
S6S-17/13	7.5		141	140	139	131	116	100	81	64
S6S-17/14	9.3		152	152	150	142	126	110	88	71
S6S-17/15	9.3		163	162	161	151	134	116	94	75
S6S-17/16	9.3		173	173	171	161	143	123	99	79
S6S-17/17	9.3		183	183	180	170	150	130	104	82
S6S-17/18	11		196	194	193	182	162	140	113	92
S6S-17/19	11		206	204	203	192	169	146	117	94
S6S-17/20	11		215	213	212	201	178	153	123	97
S6S-17/21	13		229	227	224	213	189	165	133	107
S6S-17/22	13		239	238	235	223	197	171	137	110
S6S-17/23	13		249	248	244	233	205	178	143	113
S6S-17/24	13		259	259	255	242	312	184	147	116
S6S-17/25	15		272	271	269	253	224	195	157	126
S6S-17/26	15		281	281	278	263	233	203	162	131
S6S-17/27	15		292	291	288	272	242	208	167	134
S6S-17/28	18.5		306	304	301	286	255	223	179	146
S6S-17/29	18.5		316	314	311	295	263	230	184	148
S6S-17/30	18.5		327	325	321	306	272	236	191	151
S6S-17/31	18.5		338	335	332	314	280	243	196	157
S6S-17/32	18.5		347	346	341	324	289	251	201	161
S6S-17/33	18.5		358	356	352	334	296	257	206	166
S6S-17/34	22		371	369	367	347	308	269	215	175
S6S-17/35	22		380	378	377	357	317	274	220	178
S6S-17/36	22		391	389	387	366	325	281	225	181
S6S-17/37	22		401	399	396	374	339	288	233	185
S6S-17/38	22		411	408	406	385	341	295	237	188
S6S-17/39	22		422	419	416	393	349	301	243	191
S6S-17/40	22		433	429	427	403	358	308	246	198

** Optional size.

STAINLESS STEEL SERIES

Nominal Diameter : **6"**

Nominal Flow : **17m³/h**

Outlet Size : **2½"/3"*****

Performance Curve

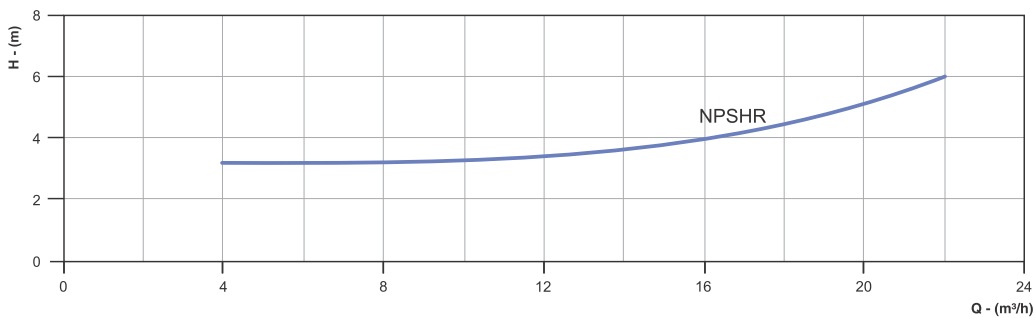
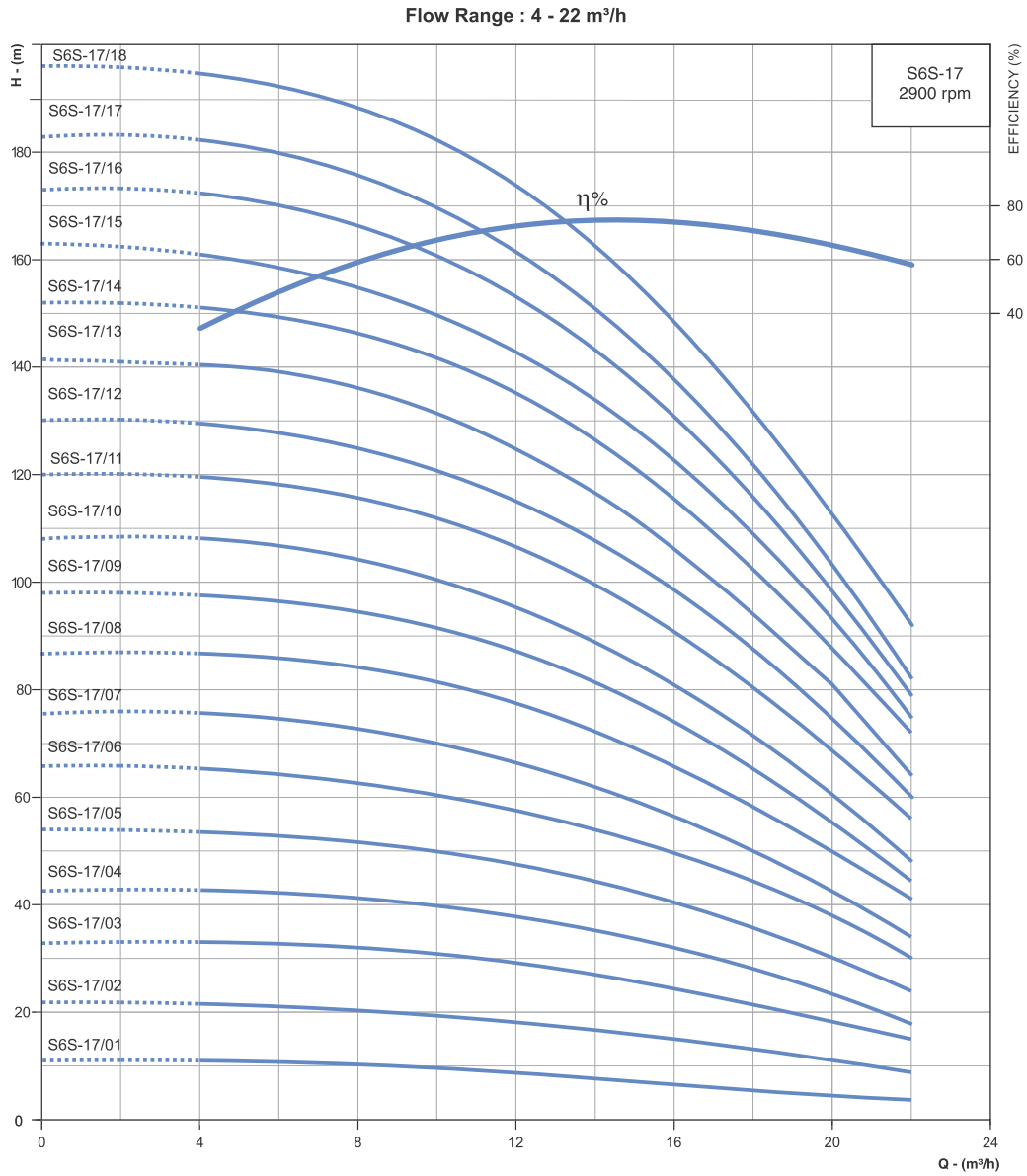

** Optional outlet Size.

In view of continuous developments, the informations / descriptions / specifications / illustrations are subject to change without notice. Refer general information for performance curve conditions and for other details. Curve tolerance according to ISO : 9906, Grade 3B

STAINLESS STEEL SERIES

Nominal Diameter : **6"**

Nominal Flow : **17m³/h**

Outlet Size : **2½"/3"*****

Performance Curves

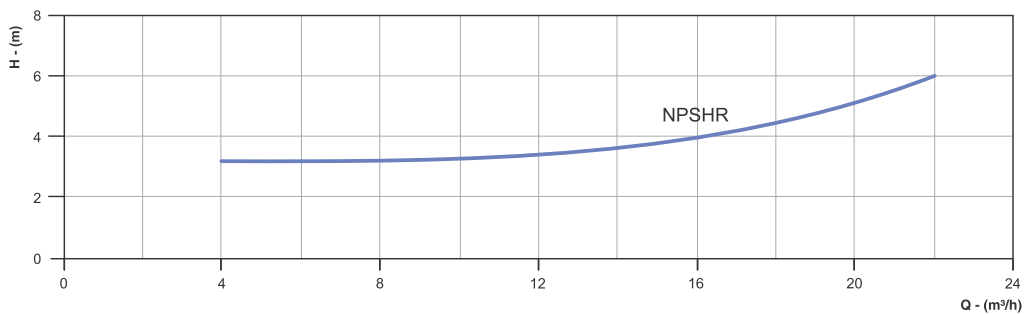
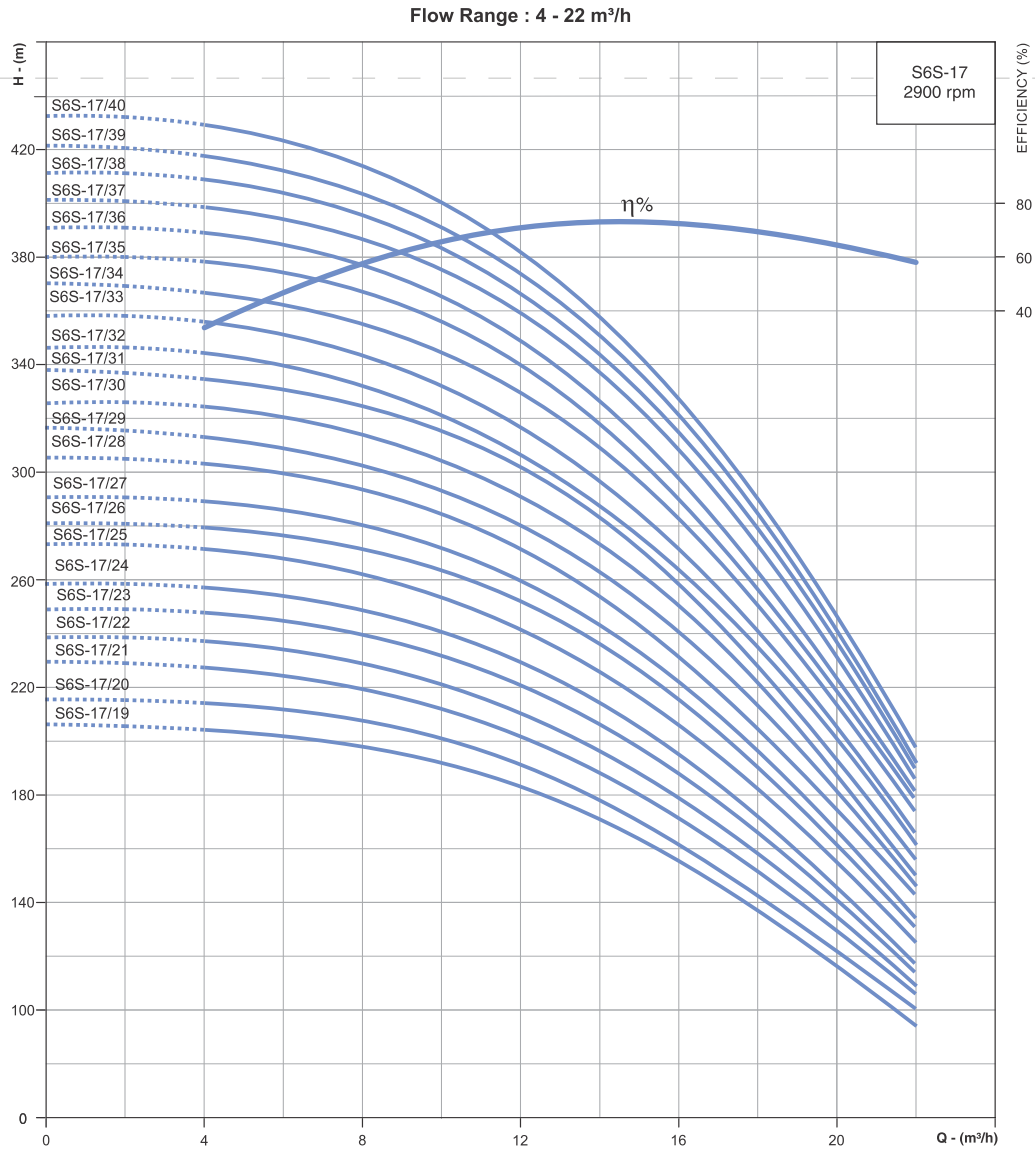

*** Optional outlet Size.

In view of continuous developments, the informations / descriptions / specifications / illustrations are subject to change without notice. Refer general information for performance curve conditions and for other details. Curve tolerance according to ISO : 9906, Grade 3B

STAINLESS STEEL SERIES

Nominal Diameter : **6"**

Nominal Flow : **17m³/h**

Outlet Size : **2½"/3"*****

Performance Table

DIMENSIONS & WEIGHT

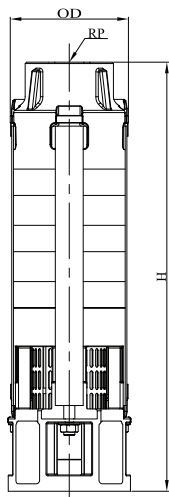

PUMP MODEL	REQUIRED MOTOR POWER		*NO OF CABLE GUARD	DIMENSIONS (mm)			APPROX NETT. WEIGHT (kg)
	kW	HP		OD	RP	H	
S6S-17/43	26	35	1/2	142/144	65	2883	66
S6S-17/45	26	35	1/2	142/144	65	3004	70
S6S-17/48	26	35	1/2	142/144	65	3186	75
S6S-17/51	30	40	1/2	142/144	65	3367	81
S6S-17/53	30	40	1/2	142/144	65	3488	85
S6S-17/55	37	50	1/2	142/144	65	3609	90
S6S-17/58	37	50	1/2	142/144	65	3791	96
S6S-17/60	37	50	1/2	142/144	65	3912	101

PUMP MODEL	MOTOR kW	lps	0	0.55	1.66	2.78	3.89	4.27	5.55	7.22
		m ³ /h	0	4	6	10	14	17	20	22
S6S-17/43	26	TOTAL MANOMETRIC HEAD IN METRES - (COLUMN WATER)	467	495	461	437	388	338	272	217
S6S-17/45	26		487	485	481	456	405	349	281	226
S6S-17/48	26		518	516	511	484	427	369	298	238
S6S-17/51	30		551	547	543	514	456	398	320	256
S6S-17/53	30		570	568	563	534	474	408	330	263
S6S-17/55	37		599	587	592	563	502	437	358	289
S6S-17/58	37		631	629	622	592	527	458	362	302
S6S-17/60	37		651	649	640	611	544	474	386	313

* 1 denotes Single Cable Guard (D.O.L - 3 wire) and 2 denotes Double Cable Guard (S.D - 6 wire). Please specify preference, while placing order.

** Optional outlet Size.

In view of continuous developments, the informations / descriptions / specifications / illustrations are subject to change without notice. Refer general information for performance curve conditions and for other details. Curve tolerance according to ISO : 9906, Grade 3B

STAINLESS STEEL SERIES

Nominal Diameter : **6"**

Nominal Flow : **17m³/h**

Outlet Size : **2½"/3" ****

Performance Curves

Flow Range : 4 - 22 m³/h

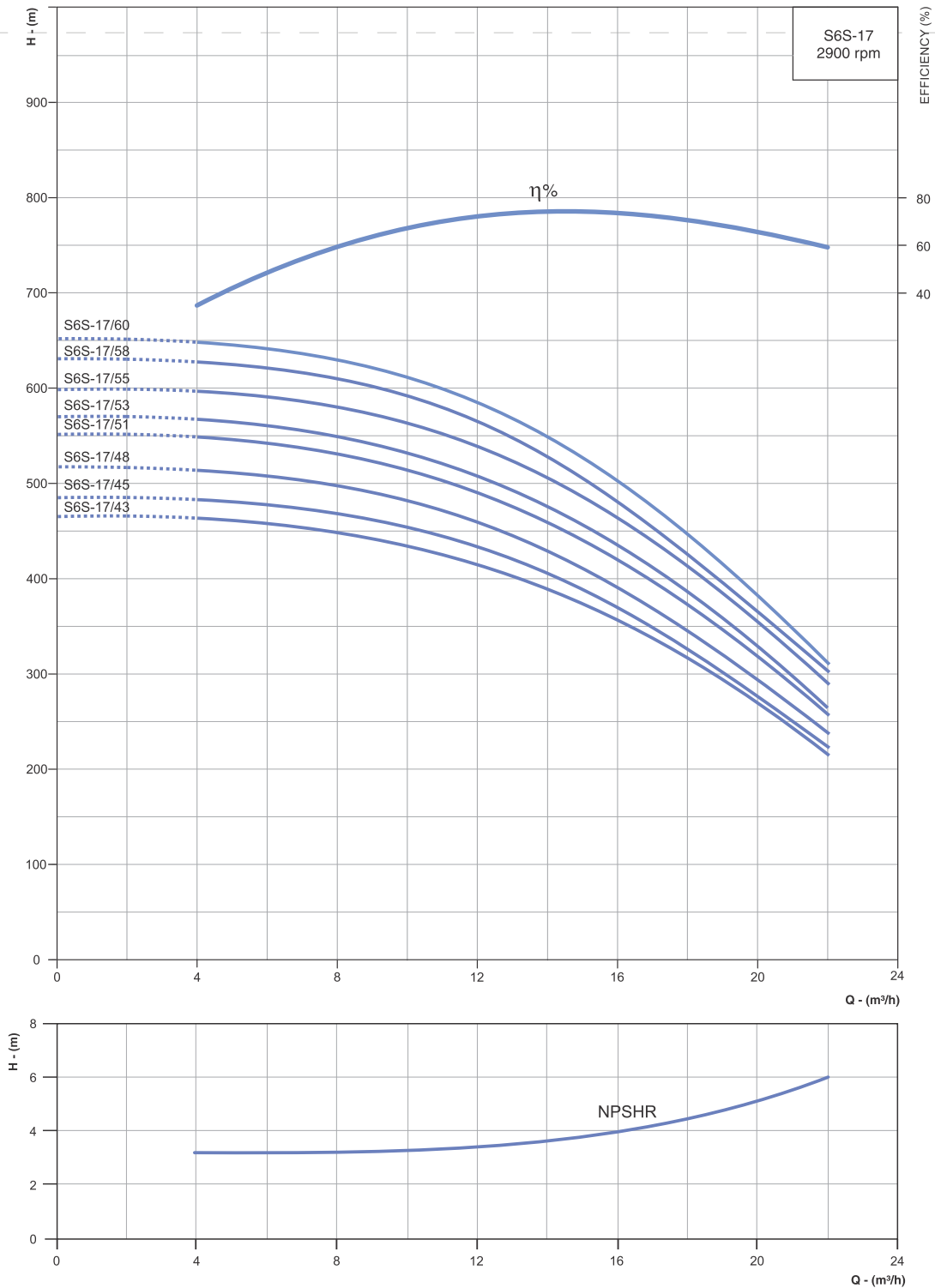

** Optional outlet Size.

In view of continuous developments, the informations / descriptions / specifications / illustrations are subject to change without notice. Refer general information for performance curve conditions and for other details. Curve tolerance according to ISO : 9906, Grade 3B

STAINLESS STEEL SERIES

Nominal Diameter : **6"**

Nominal Flow : **18m³/h**

Outlet Size : **2 1/2"**

Performance Table

DIMENSIONS & WEIGHT

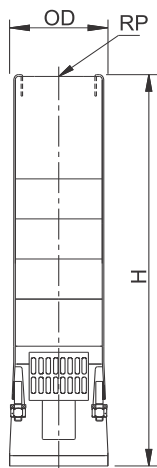

PUMP MODEL	REQUIRED MOTOR POWER		*NO OF CABLE GUARD	DIMENSIONS (mm)			APPROX NETT. WEIGHT (kg)
	kW	HP		OD	RP	H	
S6S-18/03	2.2	3	1	139	65	427	10
S6S-18/04	3	4	1	139	65	471	11
S6S-18/05	4.0	5.5	1	139	65	515	12
S6S-18/06	4.0	5.5	1	139	65	559	13
S6S-18/07	5.5	7.5	1	139	65	603	14
S6S-18/08	5.5	7.5	1/2	139/143	65	647	15
S6S-18/09	7.5	10	1/2	139/143	65	691	16
S6S-18/10	7.5	10	1/2	139/143	65	735	17
S6S-18/11	9.3	12.5	1/2	139/143	65	779	18
S6S-18/12	9.3	12.5	1/2	139/143	65	823	19
S6S-18/13	9.3	12.5	1/2	139/143	65	867	20
S6S-18/14	9.3	12.5	1/2	139/143	65	911	21
S6S-18/15	11	15	1/2	139/143	65	955	22
S6S-18/16	11	15	1/2	139/143	65	999	23
S6S-18/17	13	17.5	1/2	139/143	65	1043	24
S6S-18/18	13	17.5	1/2	139/143	65	1087	25
S6S-18/19	13	17.5	1/2	139/143	65	1131	26
S6S-18/20	15	20	1/2	139/143	65	1175	27
S6S-18/21	15	20	1/2	139/143	65	1219	28
S6S-18/22	15	20	1/2	139/143	65	1263	29
S6S-18/23	18.5	25	1/2	139/143	65	1307	30
S6S-18/24	18.5	25	1/2	139/143	65	1351	31
S6S-18/25	18.5	25	1/2	139/143	65	1395	32
S6S-18/26	18.5	25	1/2	139/143	65	1439	33
S6S-18/27	18.5	25	1/2	139/143	65	1483	33
S6S-18/28	18.5	25	1/2	139/143	65	1527	34
S6S-18/29	18.5	25	1/2	139/143	65	1571	35
S6S-18/30	18.5	25	1/2	139/143	65	1615	36
S6S-18/31	22	30	1/2	139/143	65	1659	37
S6S-18/32	22	35	1/2	139/143	65	1703	38
S6S-18/33	26	35	1/2	139/143	65	1747	39
S6S-18/34	26	35	1/2	139/143	65	1791	40
S6S-18/35	26	35	1/2	139/143	65	1835	41
S6S-18/36	26	35	1/2	139/143	65	1879	42
S6S-18/38	26	35	1/2	139/143	65	1967	44
S6S-18/40	30	40	1/2	139/143	65	2055	46
S6S-18/42	30	40	1/2	139/143	65	2143	48
S6S-18/44	30	40	1/2	139/143	65	2231	50
S6S-18/46	30	40	1/2	139/143	65	2319	52
S6S-18/48	37	50	1/2	139/143	65	2407	54
S6S-18/50	37	50	1/2	139/143	65	2570	61
S6S-18/51	37	50	1/2	139/143	65	2539	58
S6S-18/56	45	60	1/2	139/143	65	2803	63
S6S-18/60	45	60	1/2	139/143	65	2979	68
S6S-18/66	45	60	1/2	139/143	65	3243	76
S6S-18/70	45	60	1/2	139/143	65	3440	80
S6S-18/72	45	60	1/2	139/143	65	3540	83

* 1 denotes Single Cable Guard (D.O.L - 3 wire) and 2 denotes Double Cable Guard (S.D - 6 wire). Please specify preference, while placing order.

In view of continuous developments, the informations / descriptions / specifications / illustrations are subject to change without notice. Refer general information for performance curve conditions and for other details. Curve tolerance according to ISO : 9906, Grade 3B

STAINLESS STEEL SERIES

Nominal Diameter : **6"**Nominal Flow : **18m³/h**Outlet Size : **2½"**

Performance Table

PUMP MODEL	MOTOR kW	lps	0	1.66	2.22	2.78	3.33	3.89	4.44	5.00	5.56	6.11	6.67
		m ³ /h	0	6	8	10	12	14	16	18	20	22	24
S6S-18/03	2.2	TOTAL MANOMETRIC HEAD IN METRES - (COLUMN WATER)	35	37.5	33	32	30	18	25	20	16	11	6
S6S-18/04	3		48	47	46	45	44	41	38	33.5	29	24	18
S6S-18/05	4.0		58	56	55	54	52	49	46	42	37	31	25.5
S6S-18/06	4.0		70	66	65	63	61	59	56	52	46	40	33
S6S-18/07	5.5		82	78	77	75	73	70	66	61	54	47	40
S6S-18/08	5.5		95	91	89	86	84	80	76	70	63	54	45
S6S-18/09	7.5		106	102	100	98	96	92	87	80	72.5	63	54
S6S-18/10	7.5		118	103	111.5	109	106	102	98	92	83	72	60
S6S-18/11	9.3		130	125	122	119	116	112	107	100	90	78	66
S6S-18/12	9.3		142	135.5	133	130	126	122	116	108	97	84	70
S6S-18/13	9.3		152	146	144	140	136	131	124	116	105	91	76
S6S-18/14	9.3		164	157	154	151	146.5	141	134	124	112	98	82
S6S-18/15	11		175	169	166	162	158	152	145.5	136	122	106	90
S6S-18/16	11		188	179	176	172	168	162	155	145	131	104	97
S6S-18/17	13		198	190	186	183	178	172	164	154	140	122	103
S6S-18/18	13		209	199	196	192	188	182	174	164	150	132	111
S6S-18/19	13		226	216	210	204	198	190	180	168	152	133	113
S6S-18/20	15		238	225	220	215	208	201	192	180	164	144	120
S6S-18/21	15		250	236	232	227	220	212	204	192	174	152	129
S6S-18/22	15		260	248	242	237	232	224	215	202	184	162	137
S6S-18/23	18.5		274	258	252	247	240	232	222	209	191	168	143
S6S-18/24	18.5		284	264	262	256	248	240	230	216	197	175	149
S6S-18/25	18.5		296	278	271	264	256	248	236	223	204	180	154
S6S-18/26	18.5		304	287	280	272	264	256	244	228	210	185	159
S6S-18/27	18.5		316	298	290	283	274	264	252	237	216	191	164
S6S-18/28	18.5		330	308	301	292	284	274	261	244	223	197	168
S6S-18/29	18.5		340	319	311	302	292	284	272	255	231	204	175
S6S-18/30	18.5		354	337	329	312	303	292	280	264	240	210	182
S6S-18/31	22		364	348	340	323	313	303	290	272	248	219	188
S6S-18/32	22		376	360	351	332	323	312	298	280	256	227	198
S6S-18/33	26		384	370	361	342	331	320	305	287	264	236	207
S6S-18/34	26		396	379	370	351	340	326	312	294	271	244	215
S6S-18/35	26		408	389	379	359	348	336	320	302	279	252	223
S6S-18/36	26		420	399	388	368	356	343	328	309	287	260	231
S6S-18/38	26		432	404	392	384	370	356	340	320	296	268	236
S6S-18/40	30		453	427	416	405	391	375	356	332	305	274	244
S6S-18/42	30		481	450	438	425	412	395	370	348	320	286	249
S6S-18/44	30		504	472	460	448	432	413	392	367	336	300	262
S6S-18/46	30		520	495	482	468	452	432	411	386	352	312	272
S6S-18/48	37		541	517	506	492	475	456	433	405	368	324	279
S6S-18/50	30		575	533	519	503	485	465	441	412	376	330	282
S6S-18/51	37		620	567	547	525	506	482	457	426	387	340	287
S6S-18/56	45	680	623	601	577	552	523	490	452	406	353	293	
S6S-18/60	45	726	662	639	614	590	560	527	485	434	373	301	
S6S-18/66	45	809	730	705	678	652	615	578	525	472	398	325	
S6S-18/70	45	830	770	745	720	690	660	620	578	513	438	355	
S6S-18/72	45	870	790	764	738	708	675	638	590	528	448	363	

STAINLESS STEEL SERIES

Nominal Diameter : **6"**

Nominal Flow : **18m³/h**

Outlet Size : **2 1/2"**

Performance Curves

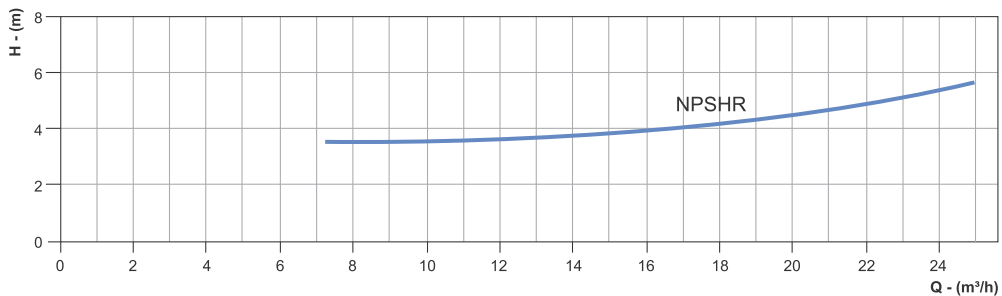
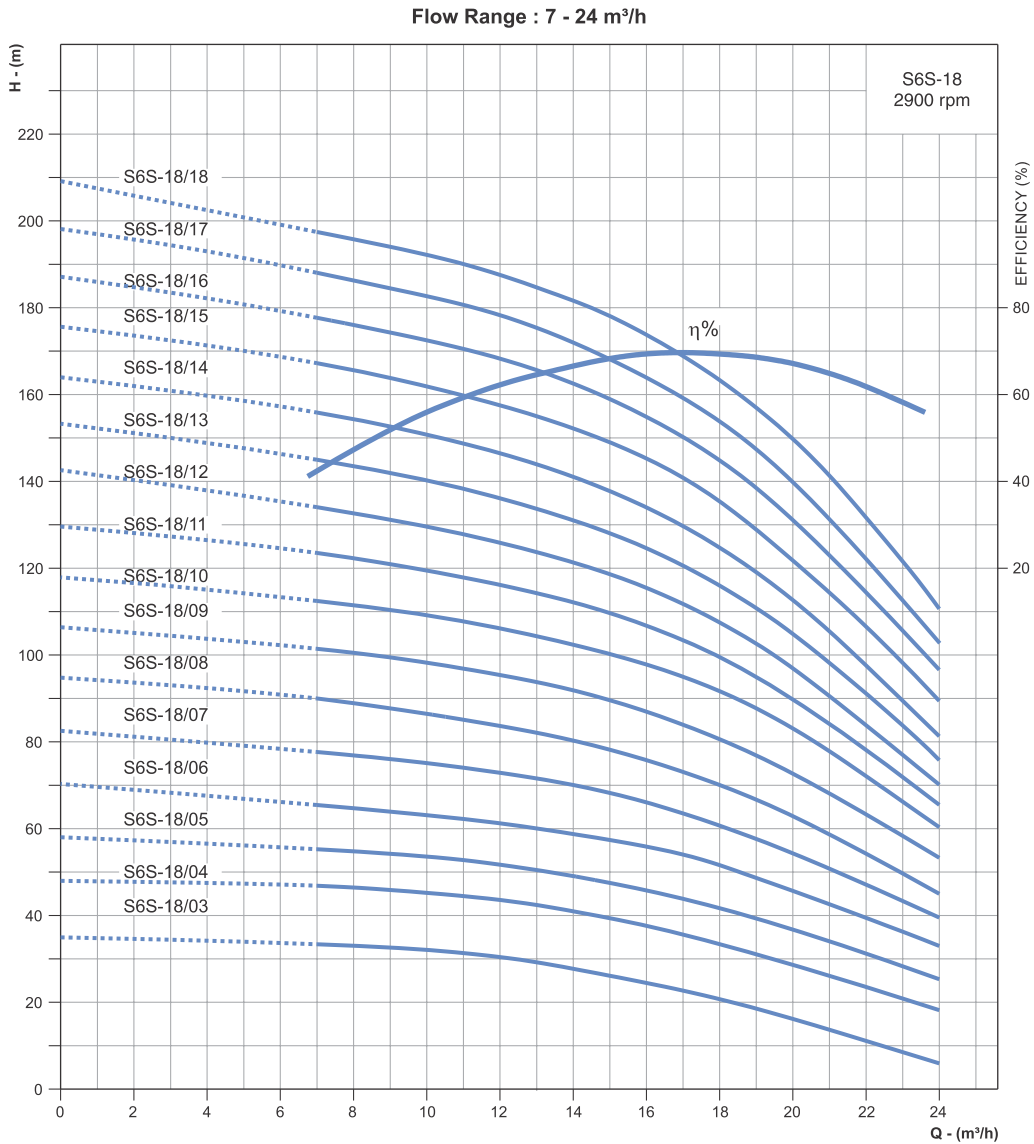

In view of continuous developments, the informations / descriptions / specifications / illustrations are subject to change without notice. Refer general information for performance curve conditions and for other details. Curve tolerance according to ISO : 9906, Grade 3B

STAINLESS STEEL SERIES

Nominal Diameter : **6"**

Nominal Flow : **18m³/h**

Outlet Size : **2 1/2"**

Performance Curves

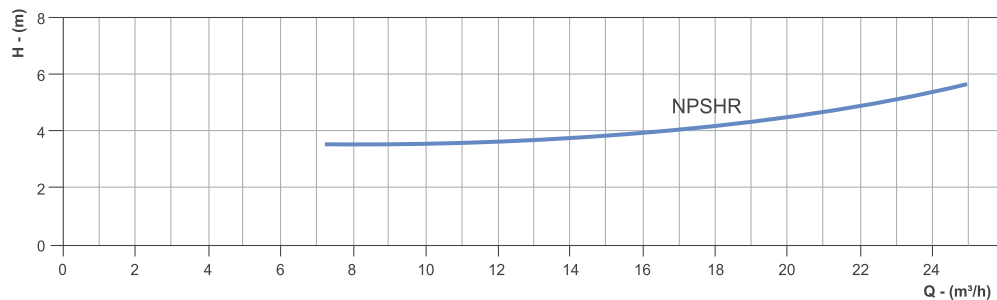
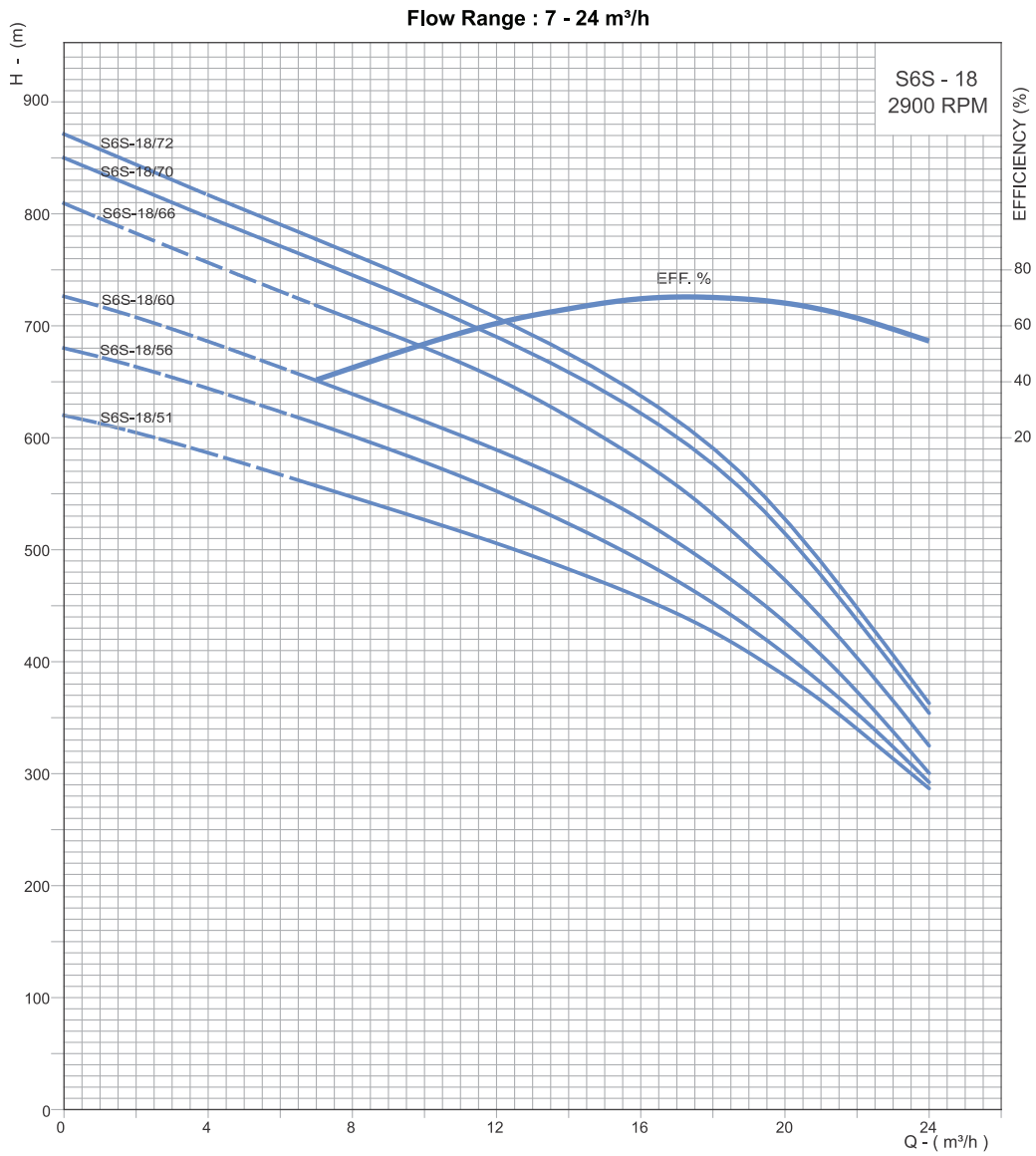

In view of continuous developments, the informations / descriptions / specifications / illustrations are subject to change without notice. Refer general information for performance curve conditions and for other details. Curve tolerance according to ISO : 9906, Grade 3B

STAINLESS STEEL SERIES

Nominal Diameter : **6"** | Nominal Flow : **22m³/h** | Outlet Size : **2½"/3"*****

Performance Table

DIMENSIONS & WEIGHT

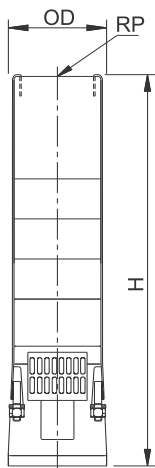

PUMP MODEL	REQUIRED MOTOR POWER		*NO OF CABLE GUARD	DIMENSIONS (mm)			APPROX NETT. WEIGHT (kg)
	kW	HP		OD	RP	H	
S6S-22/05	4.0	5.5	1	139	65/80	531	12
S6S-22/06	5.5	7.5	1	139	65/80	578	13
S6S-22/07	7.5	10	1/2	139/143	65/80	625	14
S6S-22/08	7.5	10	1/2	139/143	65/80	672	15
S6S-22/09	9.3	12.5	1/2	139/143	65/80	719	16
S6S-22/10	9.3	12.5	1/2	139/143	65/80	766	17
S6S-22/11	9.3	12.5	1/2	139/143	65/80	813	18
S6S-22/12	11	12.5	1/2	139/143	65/80	860	19
S6S-22/13	11	15	1/2	139/143	65/80	907	20
S6S-22/14	13	17.5	1/2	139/143	65/80	954	21
S6S-22/15	13	17.5	1/2	139/143	65/80	1001	22
S6S-22/16	13	17.5	1/2	139/143	65/80	1048	23
S6S-22/17	13	17.5	1/2	139/143	65/80	1095	24
S6S-22/18	15	20	1/2	139/143	65/80	1142	25
S6S-22/19	15	20	1/2	139/143	65/80	1189	26
S6S-22/20	18.5	25	1/2	139/143	65/80	1236	27
S6S-22/21	18.5	25	1/2	139/143	65/80	1283	28
S6S-22/22	18.5	25	1/2	139/143	65/80	1330	28
S6S-22/23	18.5	25	1/2	139/143	65/80	1377	29
S6S-22/24	22	30	1/2	139/143	65/80	1424	30
S6S-22/25	22	30	1/2	139/143	65/80	1471	31
S6S-22/26	22	30	1/2	139/143	65/80	1518	32
S6S-22/28	26	35	1/2	139/143	65/80	1612	34
S6S-22/30	26	35	1/2	139/143	65/80	1706	36
S6S-22/32	26	35	1/2	139/143	65/80	1800	38
S6S-22/34	26	35	1/2	139/143	65/80	1894	40
S6S-22/36	30	40	1/2	139/143	65/80	1988	42
S6S-22/38	30	40	1/2	139/143	65/80	2082	44
S6S-22/40	37	50	1/2	139/143	65/80	2176	46
S6S-22/42	37	50	1/2	139/143	65/80	2270	48
S6S-22/44	37	50	1/2	139/143	65/80	2364	50
S6S-22/46	37	50	1/2	139/143	65/80	2458	52
S6S-22/50	45	60	1/2	139/143	65/80	2646	56
S6S-22/60	55	75	1/2	139/143	65	3136	67
S6S-22/65	55	75	1/2	139/143	65	3381	72
S6S-22/72	55	75	1/2	139/143	80	3760	79

* 1 denotes Single Cable Guard (D.O.L - 3 wire) and 2 denotes Double Cable Guard (S.D - 6 wire). Please specify preference, while placing order.

** Optional outlet Size.

In view of continuous developments, the informations / descriptions / specifications / illustrations are subject to change without notice. Refer general information for performance curve conditions and for other details. Curve tolerance according to ISO : 9906, Grade 3B

STAINLESS STEEL SERIES

Nominal Diameter : **6"**Nominal Flow : **22m³/h**Outlet Size : **2½"/3"****

Performance Table

PUMP MODEL	MOTOR kW	lps	0	2.77	3.3	3.89	4.44	5	5.55	6.11	6.67	7.22	7.77
		m ³ /h	0	10	12	14	16	18	20	22	24	26	28
S6S-22/05	4.0	TOTAL MANOMETRIC HEAD IN METRES - (COLUMN WATER)	57	52	50	49	48	46	43	40	35	30	24
S6S-22/06	5.5		69	62	60	58	56	54	49	45	41	35	27
S6S-22/07	7.5		80	71	69	66	64	60	57	52	47	40	32
S6S-22/08	7.5		92	84	81	78	76	72	68	62	55	47	38
S6S-22/09	9.3		100	94	91	89	86	82	77	71	64	55	45
S6S-22/10	9.3		114	104	101	98	95	92	86	79	71	61	50
S6S-22/11	9.3		125	114	110	107	104	100	95	87	78	68	57
S6S-22/12	11		137	126	123	120	116	110	105	95	85	74	62
S6S-22/13	11		150	139	135	131	125	120	113	104	94	81	69
S6S-22/14	13		160	148	145	141	136	130	121	111	100	88	75
S6S-22/15	13		171	159	155	152	147	140	131	121	109	95	80
S6S-22/16	13		182	169	166	162	156	150	140	130	116	101	85
S6S-22/17	13		192	180	175	171	165	158	149	138	125	108	90
S6S-22/18	15		207	190	186	182	176	170	160	147	132	115	95
S6S-22/19	15		218	201	196	192	185	178	169	155	140	120	100
S6S-22/20	18.5		230	212	207	202	195	188	178	165	146	126	106
S6S-22/21	18.5		243	224	219	213	205	198	187	174	155	135	112
S6S-22/22	18.5		254	235	230	224	217	208	195	181	164	142	117
S6S-22/23	18.5		265	246	241	235	226	217	205	189	170	147	121
S6S-22/24	22		277	256	250	244	235	225	214	197	177	154	127
S6S-22/25	22		290	265	260	253	244	234	220	203	183	159	131
S6S-22/26	22		299	277	270	263	254	242	228	210	190	165	137
S6S-22/28	26		314	290	284	275	265	254	238	220	199	174	144
S6S-22/30	26		338	305	298	290	280	269	253	234	210	180	149
S6S-22/32	26		362	329	320	310	300	289	270	250	222	192	160
S6S-22/34	26		382	351	344	333	321	308	289	267	238	205	170
S6S-22/36	30		406	375	364	352	340	326	305	280	250	218	181
S6S-22/38	30		430	395	385	372	360	341	320	293	263	230	192
S6S-22/40	37		455	414	402	390	378	360	339	309	277	240	203
S6S-22/42	37		476	434	423	410	397	378	352	323	290	253	216
S6S-22/44	37		498	454	444	430	415	397	370	340	305	268	228
S6S-22/46	37		535	482	470	458	440	419	390	359	322	280	240
S6S-22/50	45	568	511	499	482	454	440	415	383	349	309	263	
S6S-22/60	45	714	650	630	606	581	552	518	472	416	358	290	
S6S-22/65	55	762	708	690	668	645	618	583	538	480	411	330	
S6S-22/72	55	850	790	765	740	710	680	642	595	535	465	390	

** Optional outlet Size.

In view of continuous developments, the informations / descriptions / specifications / illustrations are subject to change without notice.
Refer general information for performance curve conditions and for other details. Curve tolerance according to ISO : 9906, Grade 3B

STAINLESS STEEL SERIES

Nominal Diameter : **6"**

Nominal Flow : **22m³/h**

Outlet Size : **2½"/3"*****

Performance Curves

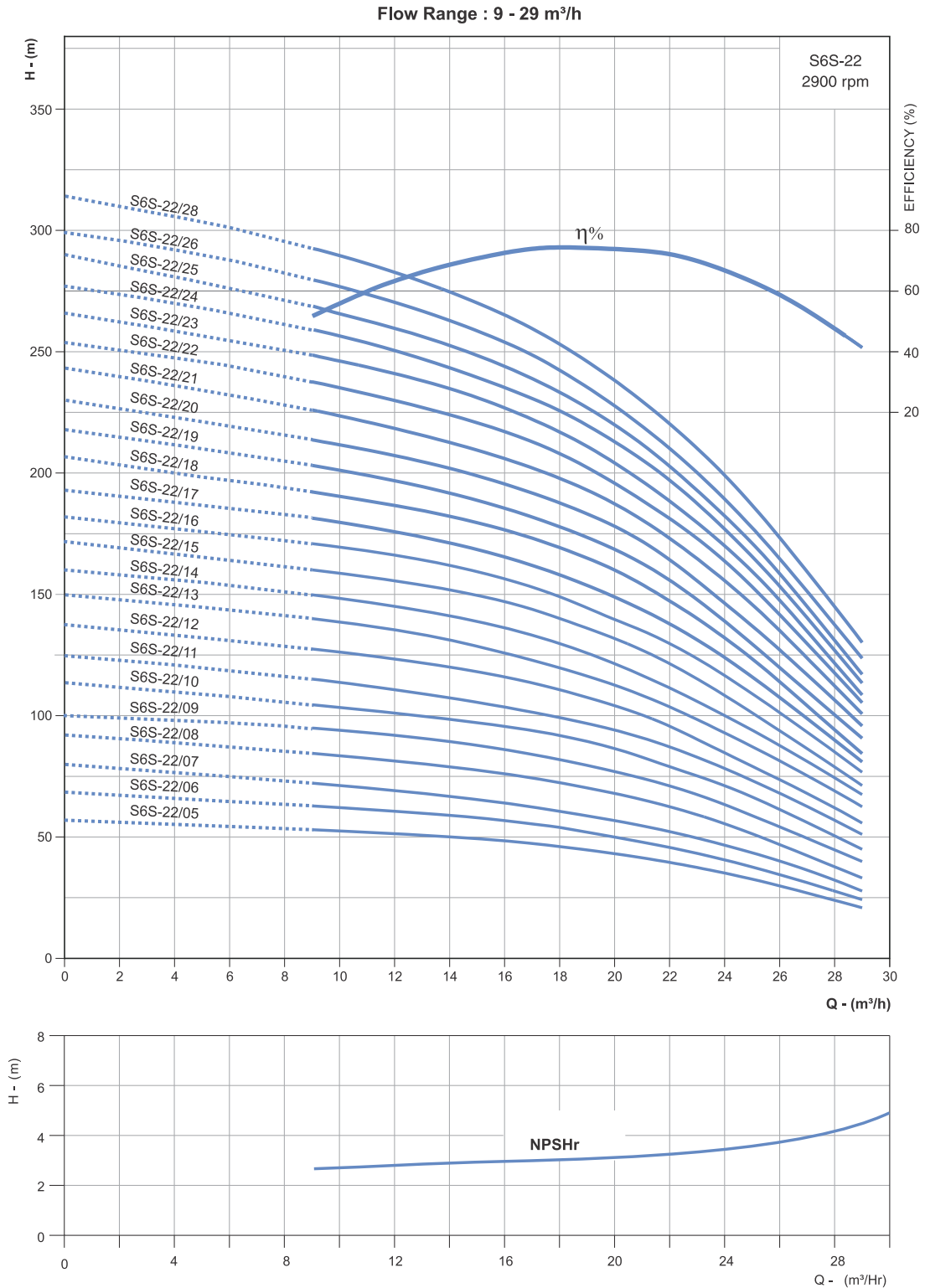

** Optional outlet Size.

In view of continuous developments, the informations / descriptions / specifications / illustrations are subject to change without notice. Refer general information for performance curve conditions and for other details. Curve tolerance according to ISO : 9906, Grade 3B

STAINLESS STEEL SERIES

Nominal Diameter : **6"**

Nominal Flow : **22m³/h**

Outlet Size : **2½"/3"*****

Performance Curves

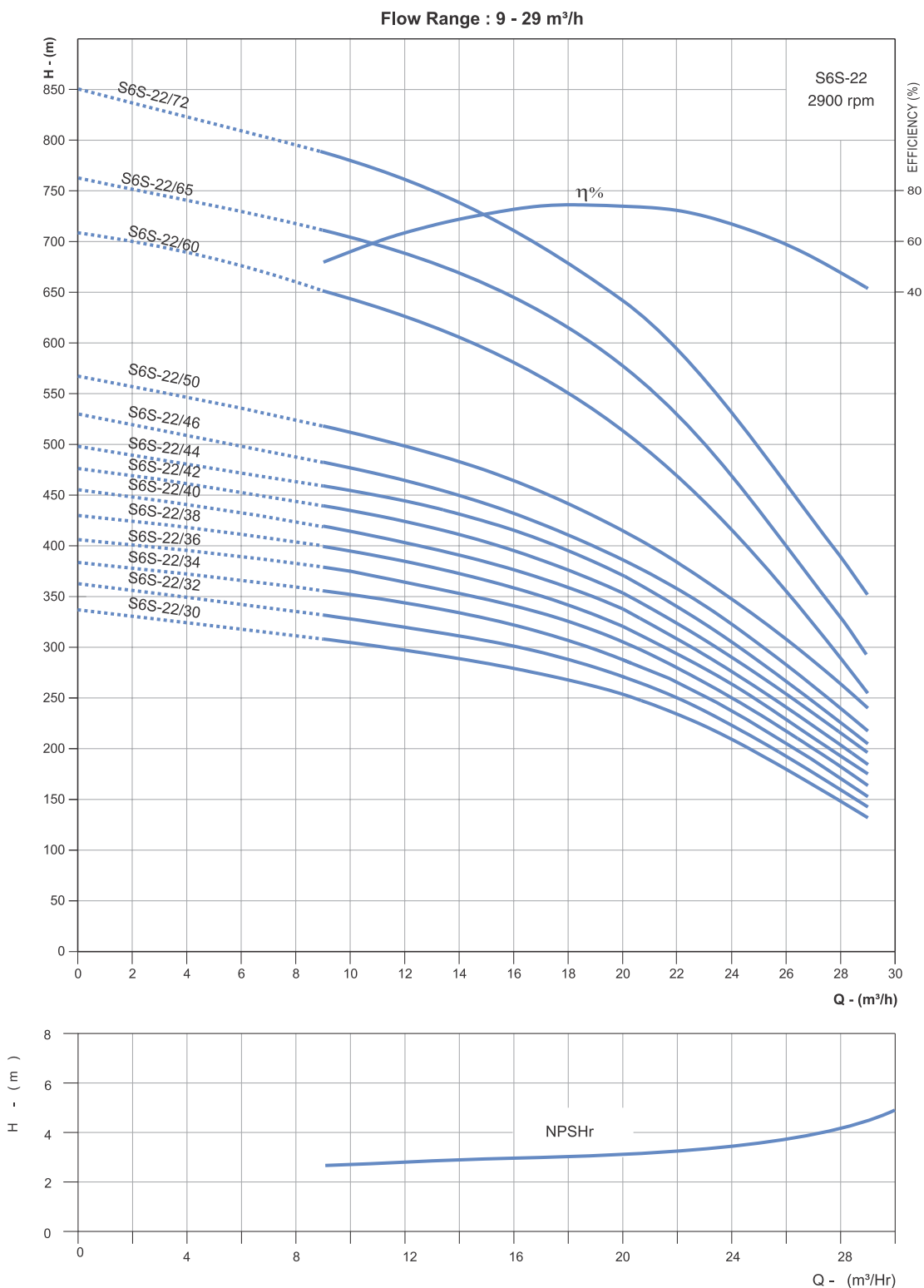

** Optional outlet Size.

In view of continuous developments, the informations / descriptions / specifications / illustrations are subject to change without notice. Refer general information for performance curve conditions and for other details. Curve tolerance according to ISO : 9906, Grade 3B

STAINLESS STEEL SERIES

Nominal Diameter : **6"**

Nominal Flow : **30m³/h**

Outlet Size : **3"**

Performance Table

DIMENSIONS & WEIGHT

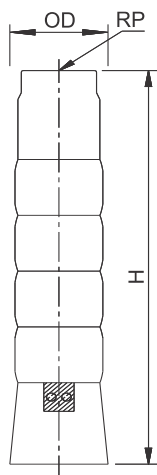

PUMP MODEL	REQUIRED MOTOR POWER		*NO OF CABLE GUARD	DIMENSIONS (mm)			APPROX NETT. WEIGHT (kg)
	kW	HP		OD	RP	H	
S6S-30/01	1.5	2	1	136	80	386	8
S6S-30/02	2.2	3	1	136	80	482	10
S6S-30/03	3	4	1	136	80	578	12
S6S-30/04	4	5.5	1	136	80	674	14
S6S-30/05	5.5	7.5	1/2	136/140	80	770	16
S6S-30/06	5.5	7.5	1/2	136/140	80	866	17
S6S-30/07	7.5	10	1/2	136/140	80	962	19
S6S-30/08	7.5	10	1/2	136/140	80	1058	21
S6S-30/09	9.3	12.5	1/2	136/140	80	1154	23
S6S-30/10	9.3	12.5	1/2	136/140	80	1250	25
S6S-30/11	9.3	12.5	1/2	136/140	80	1346	27
S6S-30/12	11	15	1/2	136/140	80	1442	29
S6S-30/13	11	15	1/2	136/140	80	1538	30
S6S-30/14	13	17.5	1/2	136/140	80	1634	33
S6S-30/15	13	17.5	1/2	136/140	80	1730	34
S6S-30/16	15	20	1/2	136/140	80	1826	36
S6S-30/17	15	20	1/2	136/140	80	1922	38
S6S-30/18	18.5	25	1/2	136/140	80	2018	40
S6S-30/19	18.5	25	1/2	136/140	80	2114	42
S6S-30/20	18.5	25	1/2	136/140	80	2210	44
S6S-30/21	18.5	25	1/2	136/140	80	2306	46
S6S-30/22	22	30	1/2	136/140	80	2402	48
S6S-30/23	22	30	1/2	136/140	80	2498	49
S6S-30/24	22	30	1/2	136/140	80	2594	51
S6S-30/25	22	30	1/2	136/140	80	2690	53
S6S-30/26	22	30	1/2	136/140	80	2786	55
S6S-30/27	26	35	1/2	136/140	80	2882	57
S6S-30/28	26	35	1/2	136/140	80	2978	59

* 1 denotes Single Cable Guard (D.O.L - 3 wire) and 2 denotes Double Cable Guard (S.D - 6 wire). Please specify preference, while placing order.

In view of continuous developments, the informations / descriptions / specifications / illustrations are subject to change without notice. Refer general information for performance curve conditions and for other details. Curve tolerance according to ISO : 9906, Grade 3B

STAINLESS STEEL SERIES

Nominal Diameter : **6"**Nominal Flow : **30m³/h**Outlet Size : **3"**

Performance Table

PUMP MODEL	MOTOR kW	lps	0	2.22	3.33	4.44	5.55	6.60	7.22	8.33	8.90	9.40	10
		m ³ /h	0	8	12	16	20	24	26	30	32	34	36
S6S-30/01	1.5	TOTAL MANOMETRIC HEAD IN METRES - (COLUMN WATER)	11	10.5	10	9	8	7	6.5	6	5	4	3.5
S6S-30/02	2.2		24	22.8	22	21	20	18.5	17.9	15.9	14	13	11
S6S-30/03	3		36.5	34	33	31.8	30	28.5	27.8	24.5	22.8	20.5	18
S6S-30/04	4		47	44	43	41.8	39.8	37	35.8	32.5	30	27	24
S6S-30/05	5.5		58.5	55	53.8	51.8	49	46.5	45	40	37	34	31
S6S-30/06	5.5		70.5	67	65	62	59	55.8	53.5	48	45	42	38
S6S-30/07	7.5		82	78	76	73	69	65	62	56	52	48.5	45
S6S-30/08	7.5		92.5	88	86	83	79	74	71	63.5	59	54.5	50
S6S-30/09	9.3		105	100	97	94	89	83	80	72	67	62	57
S6S-30/10	9.3		117	111	108	104	99	93	89.5	81	75.5	70	63
S6S-30/11	9.3		127	121	117	113	108.5	102	98	89.5	84	78	71
S6S-30/12	11		137	131	127	122.5	117	111	107	98	91.5	85	77
S6S-30/13	11		148	142	137	132	127	119	115	106	100	92	83
S6S-30/14	13		160	152	148	142	136	128	124	112	105	97	88
S6S-30/15	13		172	163	157	152	145	136	132	120	114	104	94
S6S-30/16	15		184	175	169	164	156	148	143	130	121	112	102
S6S-30/17	15		196	186	180	174	168	158	152	139	130	120	110
S6S-30/18	18.5		208	198	192	185	177	166	160	146	137	127	116
S6S-30/19	18.5		220	210	203	196	187	175	168	154	144	134	122
S6S-30/20	18.5		232	218	211	204	196	184	177	162	152	140	128
S6S-30/21	18.5		242	230	223	215	206	193	185	168	157	146	134
S6S-30/22	22		252	240	234	226	216	202	194	175	164	152	139
S6S-30/23	22		262	249	242	232	222	208	200	180	169	156	143
S6S-30/24	22		272	257	248	240	228	215	207	188	175	160	146
S6S-30/25	22		282	267	258	248	236	222	213	193	180	165	150
S6S-30/26	22		292	277	268	259	246	230	220	199	185	170	154
S6S-30/27	26		304	288	280	268	254	237	228	204	191	176	160
S6S-30/28	26		315	302	292	279	264	246	235	212	198	182	166

STAINLESS STEEL SERIES

Nominal Diameter : **6"**

Nominal Flow : **30m³/h**

Outlet Size : **3"**

Performance Curves

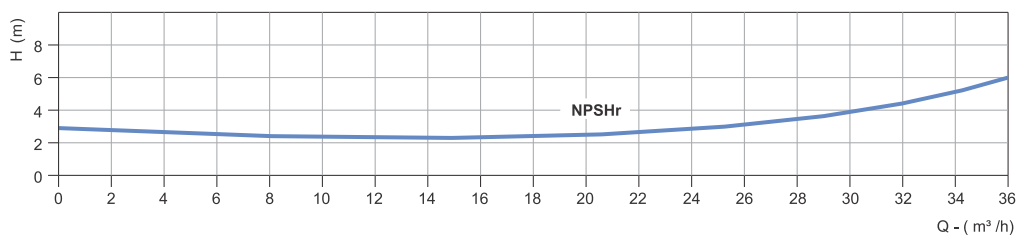
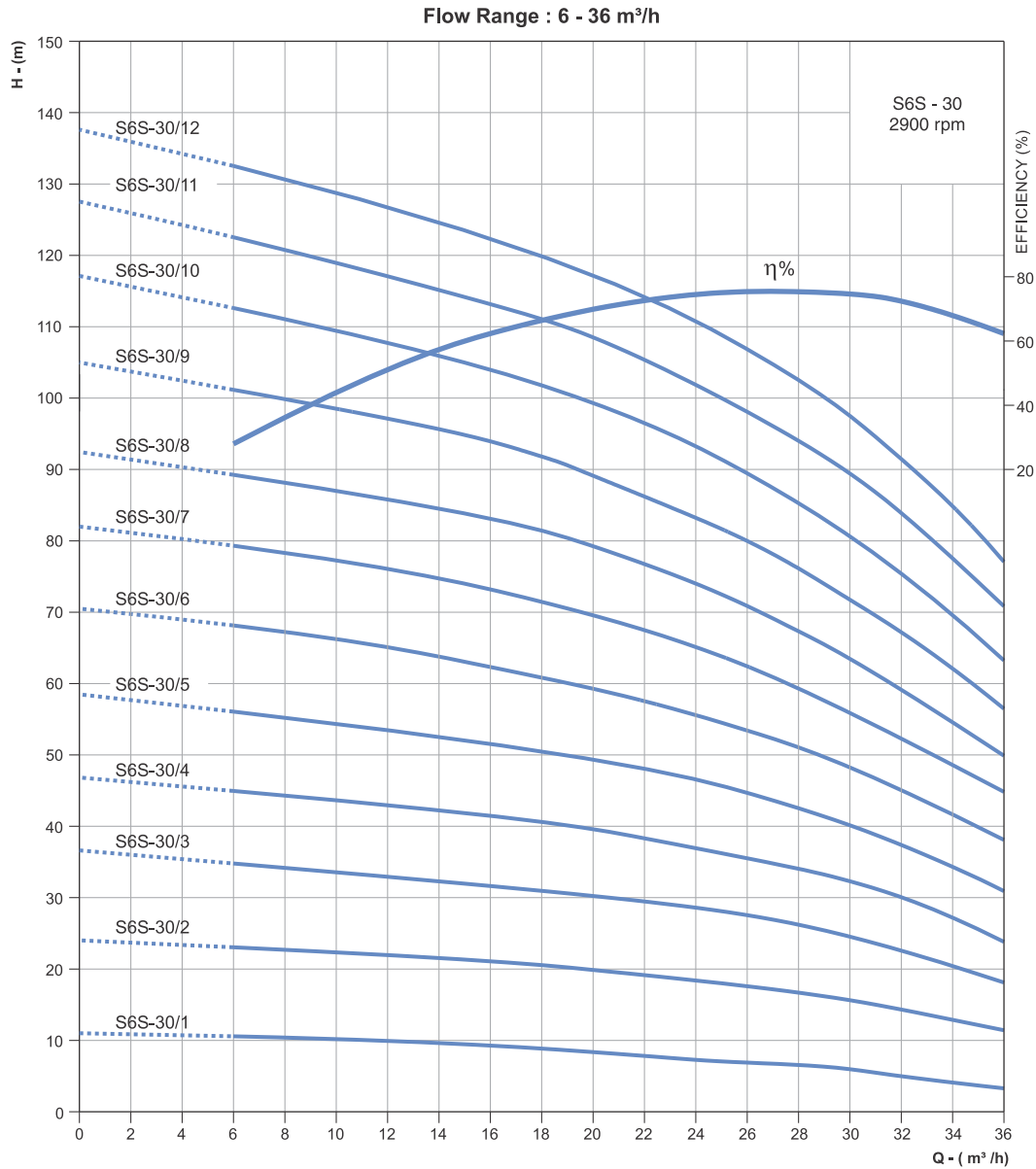

In view of continuous developments, the informations / descriptions / specifications / illustrations are subject to change without notice. Refer general information for performance curve conditions and for other details. Curve tolerance according to ISO : 9906, Grade 3B

STAINLESS STEEL SERIES

Nominal Diameter : **6"**

Nominal Flow : **30m³/h**

Outlet Size : **3"**

Performance Curves

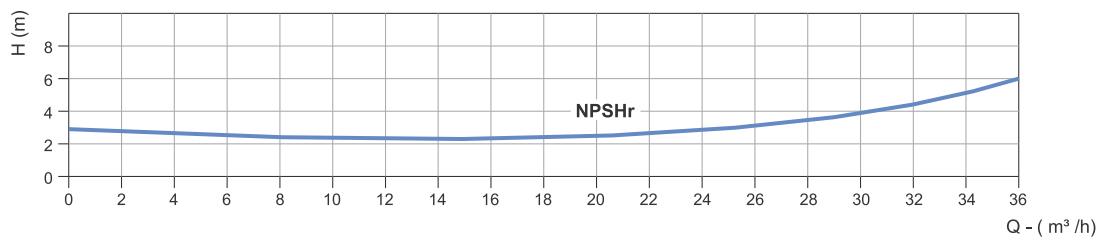
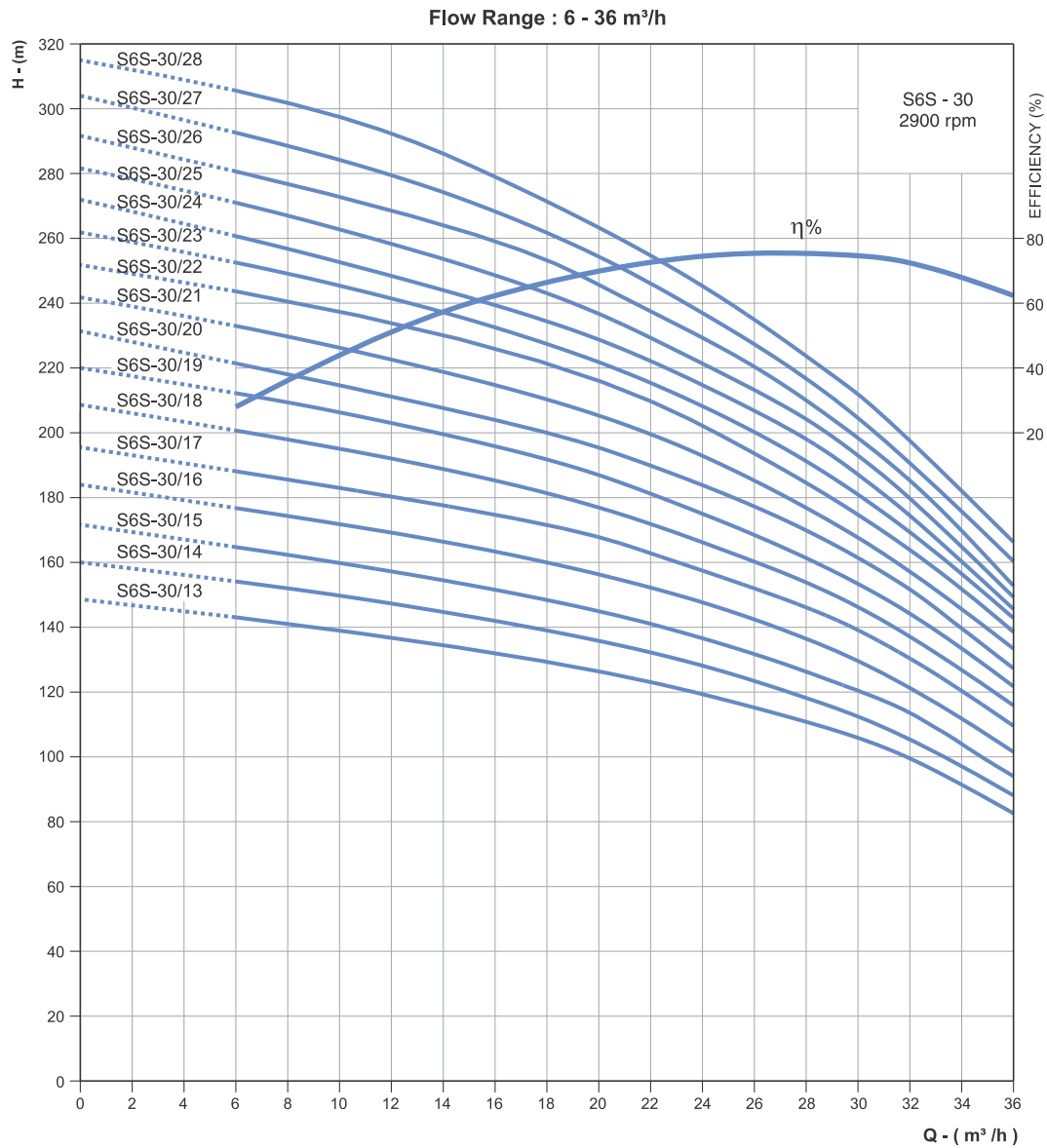

In view of continuous developments, the informations / descriptions / specifications / illustrations are subject to change without notice. Refer general information for performance curve conditions and for other details. Curve tolerance according to ISO : 9906, Grade 3B

STAINLESS STEEL SERIES

Nominal Diameter : **6"**

Nominal Flow : **30m³/h**

Outlet Size : **3"**

Performance Table

DIMENSIONS & WEIGHT

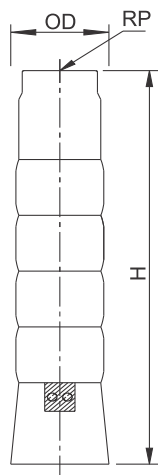

PUMP MODEL	REQUIRED MOTOR POWER		*NO OF CABLE GUARD	DIMENSIONS (mm)			APPROX NETT. WEIGHT (kg)
	kW	HP		OD	RP	H	
S6S-30/29	26	35	1/2	136/140	80	3074	61
S6S-30/31	26	35	1/2	136/140	80	3266	65
S6S-30/32	30	40	1/2	136/140	80	3362	67
S6S-30/34	30	40	1/2	136/140	80	3554	70
S6S-30/35	30	40	1/2	136/140	80	3650	72
S6S-30/38	37	50	1/2	136/140	80	3938	78
S6S-30/40	37	50	1/2	136/140	80	4130	82
S6S-30/43	37	50	1/2	136/140	80	4418	87
S6S-30/46	45	60	1/2	136/140	80	4706	93
S6S-30/49	45	60	1/2	136/140	80	4994	98
S6S-30/52	55	75	1/2	136/140	80	5282	106
S6S-30/54	55	75	1/2	136/140	80	5474	112
S6S-30/72	55	75	1/2	136/140	80	7299	150

PUMP MODEL	MOTOR kW	ips	0	2.22	3.33	4.44	5.55	6.60	7.22	8.33	8.90	9.40	10
			m ³ /h	0	8	12	16	20	24	26	30	32	34
S6S-30/29	26	TOTAL MANOMETRIC HEAD IN METRES - (COLUMN WATER)	330	323	307	287	270	250	240	214	198	183	175
S6S-30/31	26		356	343	328	312	293	273	262	233	215	200	190
S6S-30/32	30		366	355	338	322	304	283	272	245	225	207	200
S6S-30/34	30		388	375	357	340	320	298	286	255	234	210	207
S6S-30/35	30		400	387	370	350	331	307	293	263	244	222	217
S6S-30/38	37		420	417	405	385	363	336	320	290	263	247	232
S6S-30/40	37		446	437	423	401	382	357	341	304	280	260	245
S6S-30/43	37		489	477	453	430	412	381	365	326	300	276	261
S6S-30/46	45		535	515	492	467	445	415	397	352	323	300	286
S6S-30/49	45		568	550	527	501	477	447	430	384	352	325	308
S6S-30/52	55		600	587	562	535	507	473	455	409	375	346	327
S6S-30/54	55		620	607	581	553	525	492	474	426	390	360	338
S6S-30/72	75		870	793	778	739	705	658	608	583	548	500	459

* 1 denotes Single Cable Guard (D.O.L - 3 wire) and 2 denotes Double Cable Guard (S.D - 6 wire). Please specify preference, while placing order.

In view of continuous developments, the informations / descriptions / specifications / illustrations are subject to change without notice. Refer general information for performance curve conditions and for other details. Curve tolerance according to ISO : 9906, Grade 3B

STAINLESS STEEL SERIES

Nominal Diameter : **6"**

Nominal Flow : **30m³/h**

Outlet Size : **3"**

Performance Curves

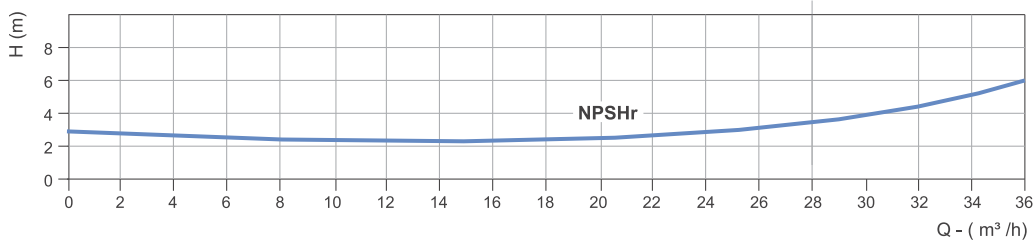
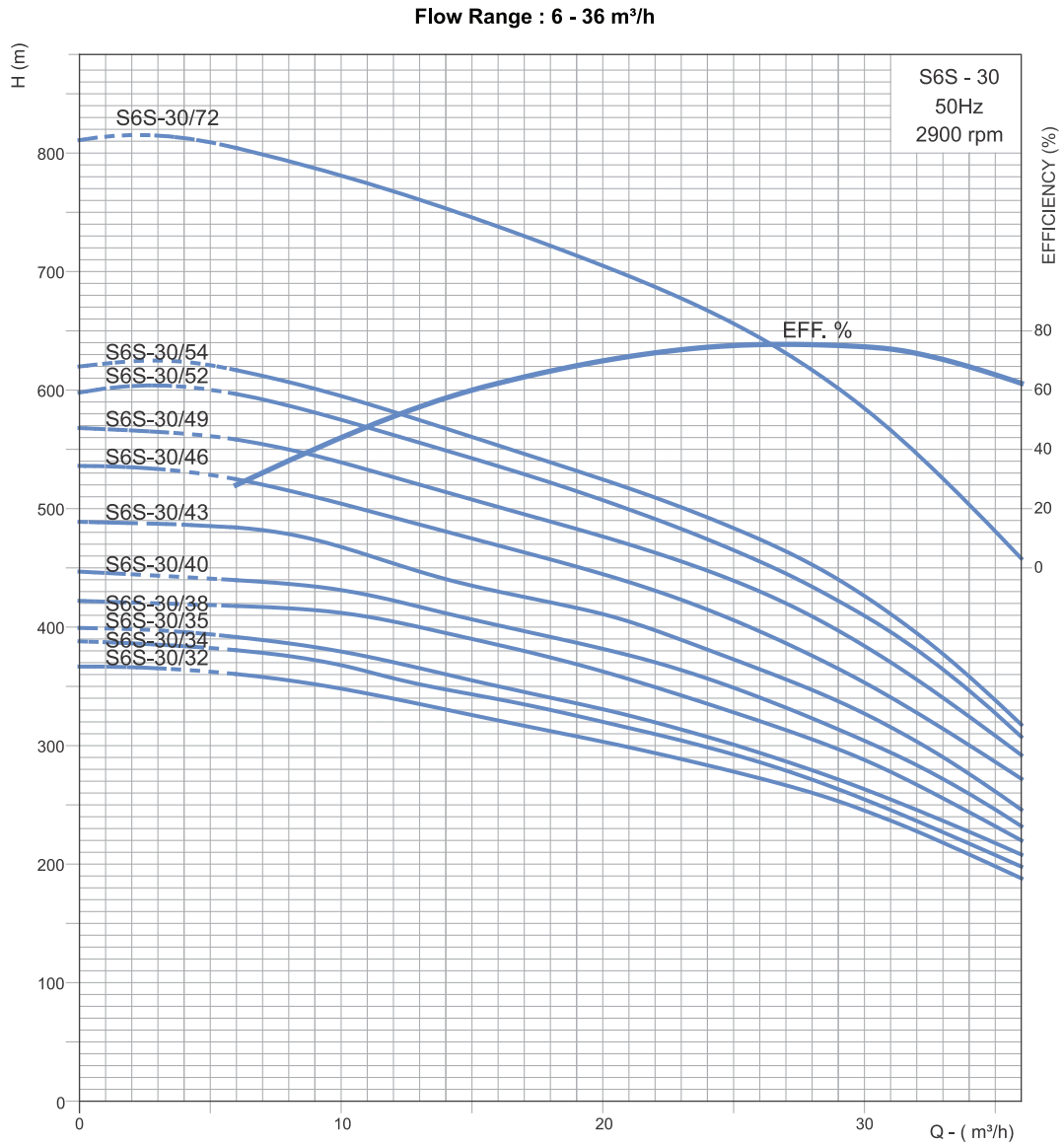

In view of continuous developments, the informations / descriptions / specifications / illustrations are subject to change without notice. Refer general information for performance curve conditions and for other details. Curve tolerance according to ISO : 9906, Grade 3B

STAINLESS STEEL SERIES

Nominal Diameter : **6"**

Nominal Flow : **48m³/h**

Outlet Size : **3"/4"*****

Performance Table

DIMENSIONS & WEIGHT

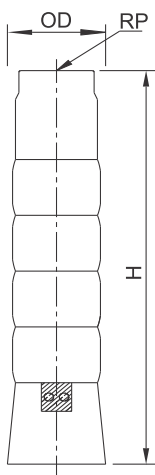

PUMP MODEL	REQUIRED MOTOR POWER		*NO OF CABLE GUARD	DIMENSIONS (mm)			APPROX NETT. WEIGHT (kg)
	kW	HP		OD	RP	H	
S6S-48/01	2.2	3	1	145	80/100	403	9
S6S-48/02	3	4	1	145	80/100	516	11
S6S-48/03	5.5	7.5	1/2	145/149	80/100	629	13
S6S-48/04	7.5	10	1/2	145/149	80/100	742	16
S6S-48/05	7.5	10	1/2	145/149	80/100	855	18
S6S-48/06	9.3	12.5	1/2	145/149	80/100	968	20
S6S-48/07	11	15	1/2	145/149	80/100	1081	22
S6S-48/08	13	17.5	1/2	145/149	80/100	1194	25
S6S-48/09	15	20	1/2	145/149	80/100	1307	27
S6S-48/10	15	20	1/2	145/149	80/100	1420	29
S6S-48/11	18.5	25	1/2	145/149	80/100	1533	32
S6S-48/12	18.5	25	1/2	145/149	80/100	1646	34
S6S-48/13	22	30	1/2	145/149	80/100	1759	36
S6S-48/14	22	30	1/2	145/149	80/100	1872	38
S6S-48/15	22	30	1/2	145/149	80/100	1985	41
S6S-48/16	26	35	1/2	145/149	80/100	2098	43
S6S-48/17	26	35	1/2	145/149	80/100	2211	45
S6S-48/18	30	40	1/2	145/149	80/100	2324	48
S6S-48/19	30	40	1/2	145/149	80/100	2437	50
S6S-48/20	37	50	1/2	145/149	80/100	2550	52
S6S-48/21	37	50	1/2	145/149	80/100	2663	54
S6S-48/22	37	50	1/2	145/149	80/100	2776	57
S6S-48/23	37	50	1/2	145/149	80/100	2889	59
S6S-48/24	37	50	1/2	145/149	80/100	3002	61
S6S-48/26	45	60	1/2	145/149	80/100	3228	66
S6S-48/28	45	60	1/2	145/149	80/100	3454	70
S6S-48/30	45	60	1/2	145/149	80/100	3680	75
S6S-48/33	55	75	1/2	145/149	80/100	4019	84
S6S-48/35	55	75	1/2	145/149	80/100	4245	89
S6S-48/37	63	85	1/2	145/149	80/100	4471	93

* 1 denotes Single Cable Guard (D.O.L - 3 wire) and 2 denotes Double Cable Guard (S.D - 6 wire). Please specify preference, while placing order.

** Optional outlet Size.

In view of continuous developments, the informations / descriptions / specifications / illustrations are subject to change without notice. Refer general information for performance curve conditions and for other details. Curve tolerance according to ISO : 9906, Grade 3B

STAINLESS STEEL SERIES

Nominal Diameter : **6"**Nominal Flow : **48m³/h**Outlet Size : **3"/4"*****

Performance Table

PUMP MODEL	MOTOR kW	lps	0	2.78	5.56	8.34	11.12	12.2	13.4	13.9	15.6	16.68
		m ³ /h	0	10	20	30	40	44	48	50	56	60
S6S-48/01	2.2	TOTAL MANOMETRIC HEAD IN METRES - (COLUMN WATER)	13.5	13	12	10.5	9	8	7	6.8	5	3.8
S6S-48/02	3		26.8	25.5	23.5	21	18	16.5	15	14	11	8.5
S6S-48/03	5.5		40.8	39	36	32.5	28.5	26	24	23	18	14.5
S6S-48/04	7.5		54.2	52	48.2	43.8	38	35.5	32	30.8	24	20
S6S-48/05	7.5		67	64	59.5	53.8	47	44	40	37.8	30	24
S6S-48/06	9.3		80.5	77	71.5	65	56.5	52	48	45.5	36	29.8
S6S-48/07	11		94	90	84	75.8	66.2	62	56	53.5	42.5	35
S6S-48/08	13		108	103	96	87.3	76.5	71	65	61.8	50	41
S6S-48/09	15		121	116	108	98.2	86.2	80	74	69.8	56	46
S6S-48/10	15		134	128	119	108	95	88	80	76	61	51
S6S-48/11	18.5		148	142	133	120	105.5	98.5	90	85.8	68	56
S6S-48/12	18.5		161	154	144	130	114	106	98	92.2	74	62
S6S-48/13	22		176	168	157.5	143.5	125.8	117.5	108	102	82	67.5
S6S-48/14	22		188	179	168	153	135	130	115	109	89	72
S6S-48/15	22		201	192	178	163	143	132	121	115	94	76
S6S-48/16	26		216	207	193	175	154	144	131	125	100	84
S6S-48/17	26		228	219	204	186	162	151	139	132	109	88
S6S-48/18	30		243	233	217	197	174	161	149	141	116	95
S6S-48/19	30		256	245	228	206	182	170	155	148	120	99
S6S-48/20	37		268	256	240	217	191	179	163	154	125	103
S6S-48/21	37		284	273	255	233	205	181	176	167	136	113
S6S-48/22	37		297	285	266	243	214	200	182	174	140	117
S6S-48/23	37		310	297	278	253	222	207	190	180	148	121
S6S-48/24	37		323	310	289	263	231	216	199	188	152	124
S6S-48/26	45		357	343	323	295	261	245	226	215	179	148
S6S-48/28	45		383	367	345	316	280	261	240	229	190	159
S6S-48/30	45		407	390	366	335	295	276	251	240	199	164
S6S-48/33	55		450	433	405	370	328	308	281	268	220	184
S6S-48/35	55		476	456	428	392	347	325	299	283	231	193
S6S-48/37	63		505	484	454	416	368	345	319	301	249	207

**Optional outlet Size.

STAINLESS STEEL SERIES

Nominal Diameter : **6"**

Nominal Flow : **48m³/h**

Outlet Size : **3"/4"*****

Performance Curves

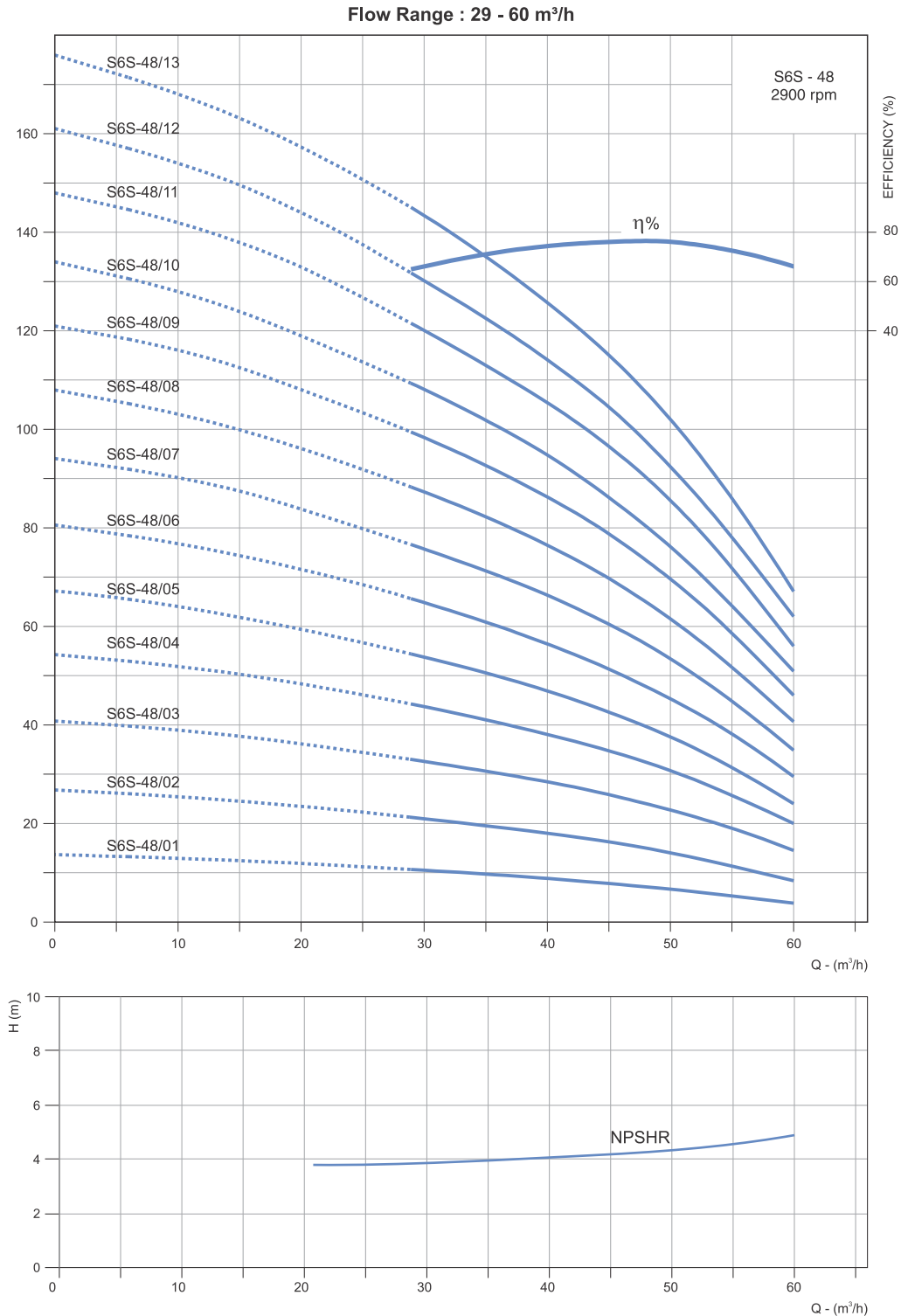

In view of continuous developments, the informations / descriptions / specifications / illustrations are subject to change without notice. Refer general information for performance curve conditions and for other details. Curve tolerance according to ISO : 9906, Grade 3B

STAINLESS STEEL SERIES

Nominal Diameter : **6"**

Nominal Flow : **48m³/h**

Outlet Size : **3"/4"*****

Performance Curves

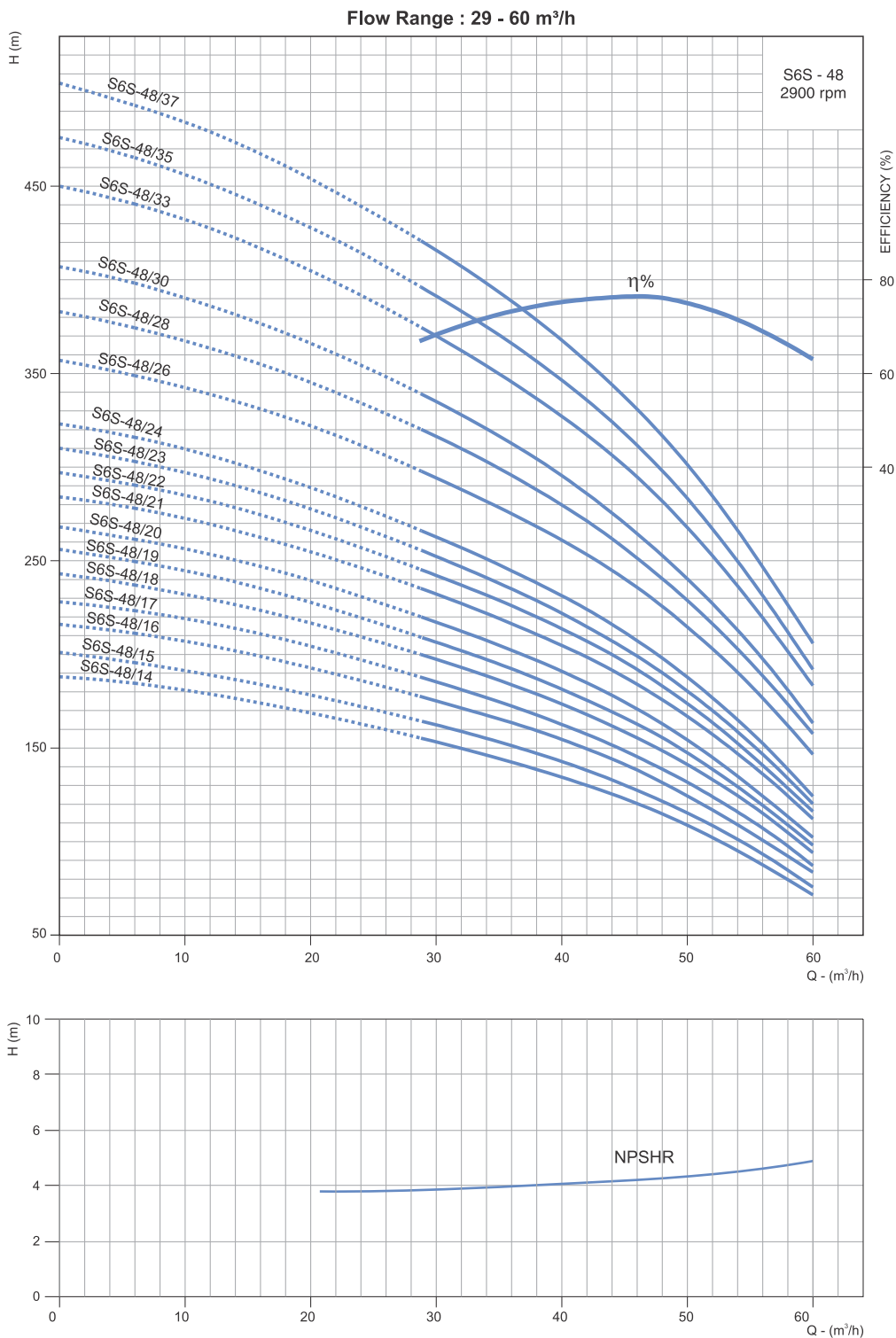

In view of continuous developments, the informations / descriptions / specifications / illustrations are subject to change without notice. Refer general information for performance curve conditions and for other details. Curve tolerance according to ISO : 9906, Grade 3B

STAINLESS STEEL SERIES

Nominal Diameter : **6"**

Nominal Flow : **60m³/h**

Outlet Size : **3"/4"*****

Performance Table

DIMENSIONS & WEIGHT

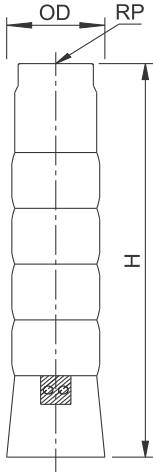

PUMP MODEL	REQUIRED MOTOR POWER		*NO OF CABLE GUARD	DIMENSIONS (mm)			APPROX NETT. WEIGHT (kg)
	kW	HP		OD	RP	H	
S6S-60/01	2.2	3	1	145	80/100		6
S6S-60/02	4	5.5	1	145	80/100	516	11
S6S-60/03	5.5	7.5	1/2	145/149	80/100	629	13
S6S-60/04	7.5	10	1/2	145/149	80/100	742	16
S6S-60/05	9.3	12.5	1/2	145/149	80/100	855	18
S6S-60/06	11	15	1/2	145/149	80/100	968	21
S6S-60/07	13	17.5	1/2	145/149	80/100	1081	23
S6S-60/08	15	20	1/2	145/149	80/100	1194	25
S6S-60/09	18.5	25	1/2	145/149	80/100	1307	28
S6S-60/10	18.5	25	1/2	145/149	80/100	1420	30
S6S-60/11	22	30	1/2	145/149	80/100	1533	32
S6S-60/12	22	30	1/2	145/149	80/100	1646	35
S6S-60/13	26	35	1/2	145/149	80/100	1759	37
S6S-60/14	26	35	1/2	145/149	80/100	1872	39
S6S-60/15	26	35	1/2	145/149	80/100	1985	42
S6S-60/16	30	40	1/2	145/149	80/100	2098	44
S6S-60/17	30	40	1/2	145/149	80/100	2211	46
S6S-60/18	37	50	1/2	145/149	80/100	2324	49
S6S-60/19	37	50	1/2	145/149	80/100	2437	51
S6S-60/20	37	50	1/2	145/149	80/100	2550	53
S6S-60/21	37	50	1/2	145/149	80/100	2663	56
S6S-60/22	45	60	1/2	145/149	80/100	2776	58
S6S-60/24	45	60	1/2	145/149	80/100	3002	63
S6S-60/26	55	75	1/2	145/149	80/100	3228	70
S6S-60/28	55	75	1/2	145/149	80/100	3454	74
S6S-60/30	55	75	1/2	145/149	80/100	3680	79

* 1 denotes Single Cable Guard (D.O.L - 3 wire) and 2 denotes Double Cable Guard (S.D - 6 wire). Please specify preference, while placing order.

** Optional outlet Size.

In view of continuous developments, the informations / descriptions / specifications / illustrations are subject to change without notice. Refer general information for performance curve conditions and for other details. Curve tolerance according to ISO : 9906, Grade 3B

STAINLESS STEEL SERIES

Nominal Diameter : **6"**Nominal Flow : **60m³/h**Outlet Size : **3"/4"*****

Performance Table

PUMP MODEL	MOTOR kW	lps	0	4.16	5.55	8.33	11.11	13.88	16.66	19.44	22.22
		m ³ /h	0	15	20	30	40	50	60	70	80
S6S-60/01	2.2	TOTAL MANOMETRIC HEAD IN METRES - (COLUMN WATER)	14	13	12	11	9	7	5	3	1
S6S-60/02	4		26	25	24	23	20	17	14	10	5
S6S-60/03	5.5		39	38	37	35	32	27	22	15	9
S6S-60/04	7.5		52	51	50	47	42	37	31	22	13
S6S-60/05	9.3		67	64	63	59	53	45	37	28	16
S6S-60/06	11		82	78	76	71	63	56	47	35	21
S6S-60/07	13		94	91	89	83	73	66	55	41	24
S6S-60/08	15		110	104	102	97	87	76	65	48	30
S6S-60/09	18.5		122	114	112	106	95	84	70	54	33
S6S-60/10	18.5		138	133	128	118	105	92	76	57	35
S6S-60/11	22		148	142	138	128	114	101	86	65	40
S6S-60/12	22		167	156	152	141	124	109	92	69	43
S6S-60/13	26		180	170	165	153	137	120	100	75	45
S6S-60/14	26		195	184	179	164	144	128	110	83	48
S6S-60/15	26		212	198	194	177	157	137	117	85	52
S6S-60/16	30		220	213	207	188	167	147	127	89	57
S6S-60/17	30		242	227	222	205	183	160	138	107	63
S6S-60/18	37		252	240	233	212	189	176	142	112	67
S6S-60/19	37		270	254	248	231	206	181	152	116	74
S6S-60/20	37		282	276	267	259	216	189	162	126	80
S6S-60/21	37		300	288	281	254	223	195	165	126	77
S6S-60/22	45		318	306	298	270	238	207	176	138	84
S6S-60/24	45		339	324	314	285	251	218	186	144	90
S6S-60/26	55		370	354	344	312	275	239	204	156	96
S6S-60/28	55		396	378	367	332	293	255	216	161	101
S6S-60/30	55		420	402	390	354	312	270	228	176	107

STAINLESS STEEL SERIES

Nominal Diameter : **6"**

Nominal Flow : **60m³/h**

Outlet Size : **3"/4"*****

Performance Curves

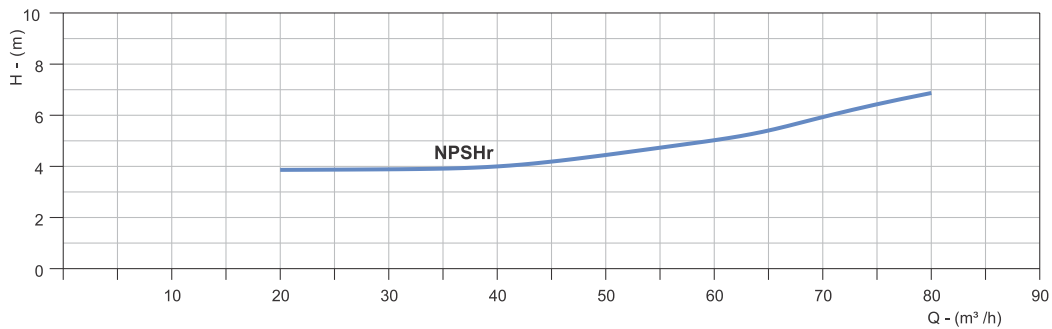
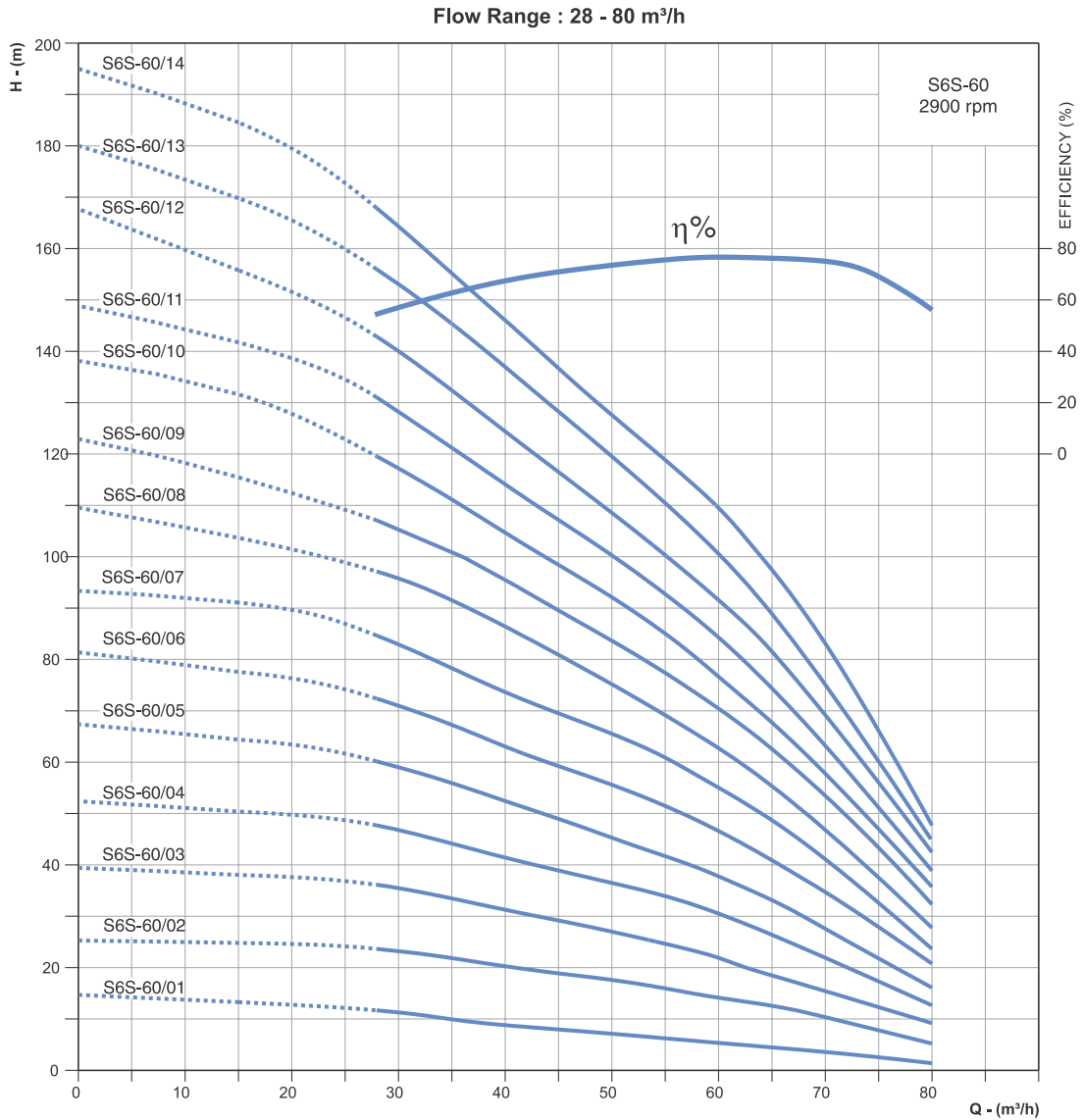

** Optional outlet Size.

In view of continuous developments, the informations / descriptions / specifications / illustrations are subject to change without notice. Refer general information for performance curve conditions and for other details. Curve tolerance according to ISO : 9906, Grade 3B

STAINLESS STEEL SERIES

Nominal Diameter : **6"**

Nominal Flow : **60m³/h**

Outlet Size : **3"/4"*****

Performance Curves

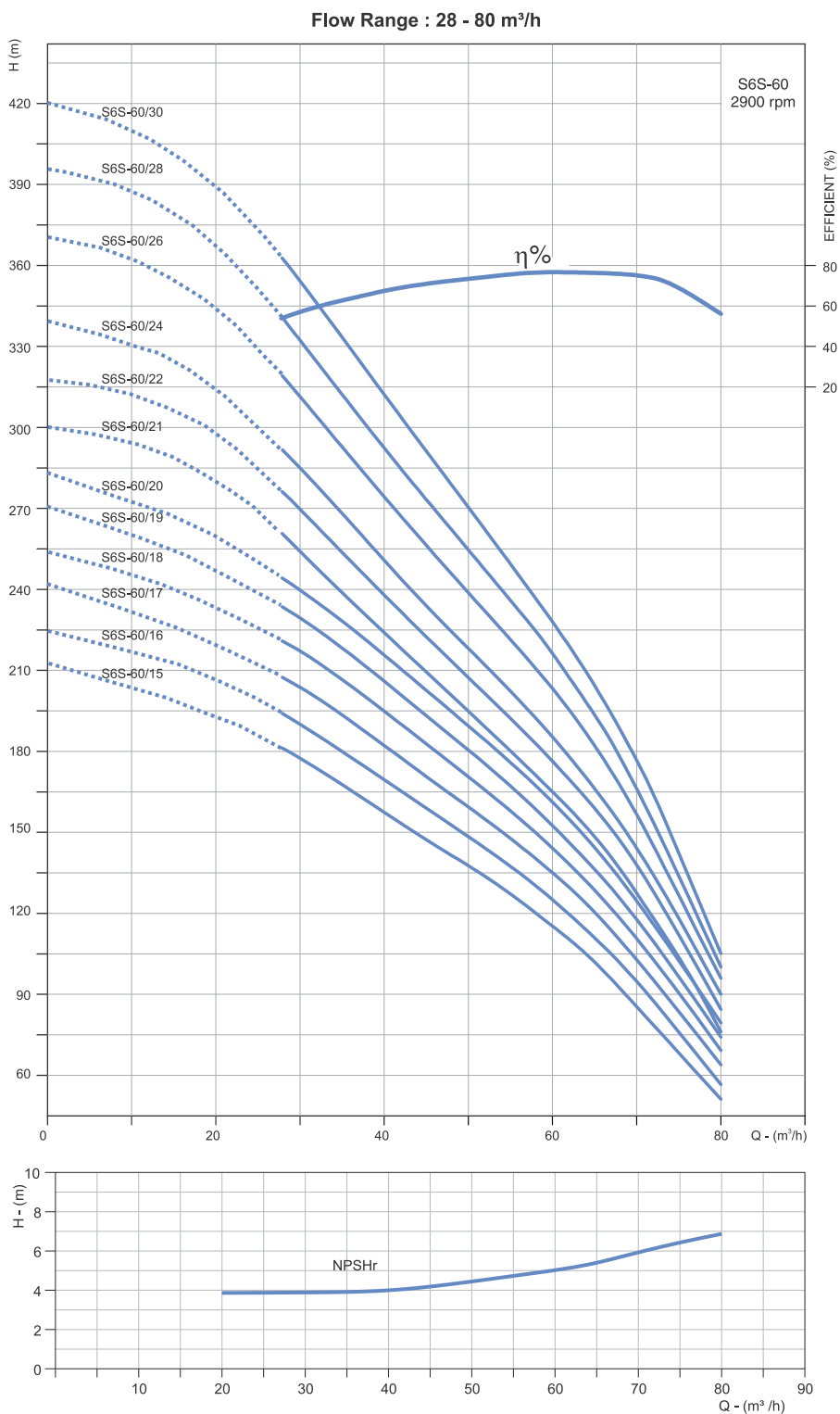

** Optional outlet Size.

In view of continuous developments, the informations / descriptions / specifications / illustrations are subject to change without notice. Refer general information for performance curve conditions and for other details. Curve tolerance according to ISO : 9906, Grade 3B

STAINLESS STEEL SERIES

Nominal Diameter : **6"**

Nominal Flow : **76m³/h**

Outlet Size : **3"/4"*****

Performance Table

DIMENSIONS & WEIGHT

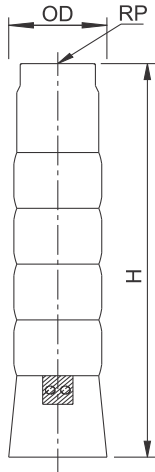

PUMP MODEL	REQUIRED MOTOR POWER		*NO OF CABLE GUARD	DIMENSIONS (mm)			APPROX NETT. WEIGHT (kg)
	kW	HP		#OD	RP	H	
S6S-76/01	3	4	1	149/153	100	457	11
S6S-76/02	5.5	7.5	1/2	149/153	100	601	14
S6S-76/03	7.5	10	1/2	149/153	100	745	17
S6S-76/04	11	15	1/2	149/153	100	889	20
S6S-76/05	13	17.5	1/2	149/153	100	1033	23
S6S-76/06	15	20	1/2	149/153	100	1177	26
S6S-76/07	18.5	25	1/2	149/153	100	1321	29
S6S-76/08	18.5	25	1/2	149/153	100	1465	32
S6S-76/09	22	30	1/2	149/153	100	1609	35
S6S-76/10	25	35	1/2	149/153	100	1753	38
S6S-76/11	30	40	1/2	149/153	100	1897	41
S6S-76/12	30	40	1/2	149/153	100	2041	44
S6S-76/13	37	50	1/2	149/153	100	2185	47
S6S-76/14	37	50	1/2	149/153	100	2329	50
S6S-76/15	37	50	1/2	149/153	100	2473	54
S6S-76/16	45	60	1/2	149/153	100	2617	57
S6S-76/17	45	60	1/2	149/153	100	2761	60
S6S-76/18	45	60	1/2	149/153	100	2905	63

PUMP MODEL	MOTOR kW	lps	0	11.1	15.3	18.1	19.4	20.8	22.2	23.6	25.0	26.4
		m ³ /h	0	40	55	65	70	75	80	85	90	95
S6S-76/01	3	TOTAL MANOMETRIC HEAD IN METRES - (COLUMN WATER)	17	12	11	10	9	8	7	7	5	4
S6S-76/02	5.5		34	23	21	20	18	16	15	13	11	8
S6S-76/03	7.5		51	35	32	30	28	25	22	20	16	13
S6S-76/04	11		67	47	43	39	37	33	29	26	21	17
S6S-76/05	13		84	58	53	49	46	41	37	33	27	21
S6S-76/06	15		101	70	64	59	55	49	44	39	32	25
S6S-76/07	18.5		118	82	75	69	64	57	51	46	37	29
S6S-76/08	18.5		135	93	85	79	73	65	59	52	43	33
S6S-76/09	22		152	105	96	89	83	74	66	59	48	38
S6S-76/10	25		168	117	107	98	92	82	73	65	53	42
S6S-76/11	30		185	128	117	108	101	90	81	72	59	46
S6S-76/12	30		202	140	128	118	110	98	88	78	64	50
S6S-76/13	37		219	152	139	128	119	106	95	85	69	54
S6S-76/14	37		236	163	149	138	128	114	103	91	75	58
S6S-76/15	37		253	175	160	148	138	123	110	98	80	63
S6S-76/16	45		269	187	171	157	147	131	117	104	85	67
S6S-76/17	45		286	198	181	167	156	139	125	111	91	71
S6S-76/18	45		303	210	192	177	165	147	132	117	96	75

* 1 denotes Single Cable Guard (D.O.L - 3 wire) and 2 denotes Double Cable Guard (S.D - 6 wire). Please specify preference, while placing order.

In view of continuous developments, the informations / descriptions / specifications / illustrations are subject to change without notice. Refer general information for performance curve conditions and for other details. Curve tolerance according to ISO : 9906, Grade 3B

STAINLESS STEEL SERIES

Nominal Diameter : **6"**

Nominal Flow : **76m³/h**

Outlet Size : **3"/4"*****

Performance Curves

Flow Range : 40 - 95 m³/h

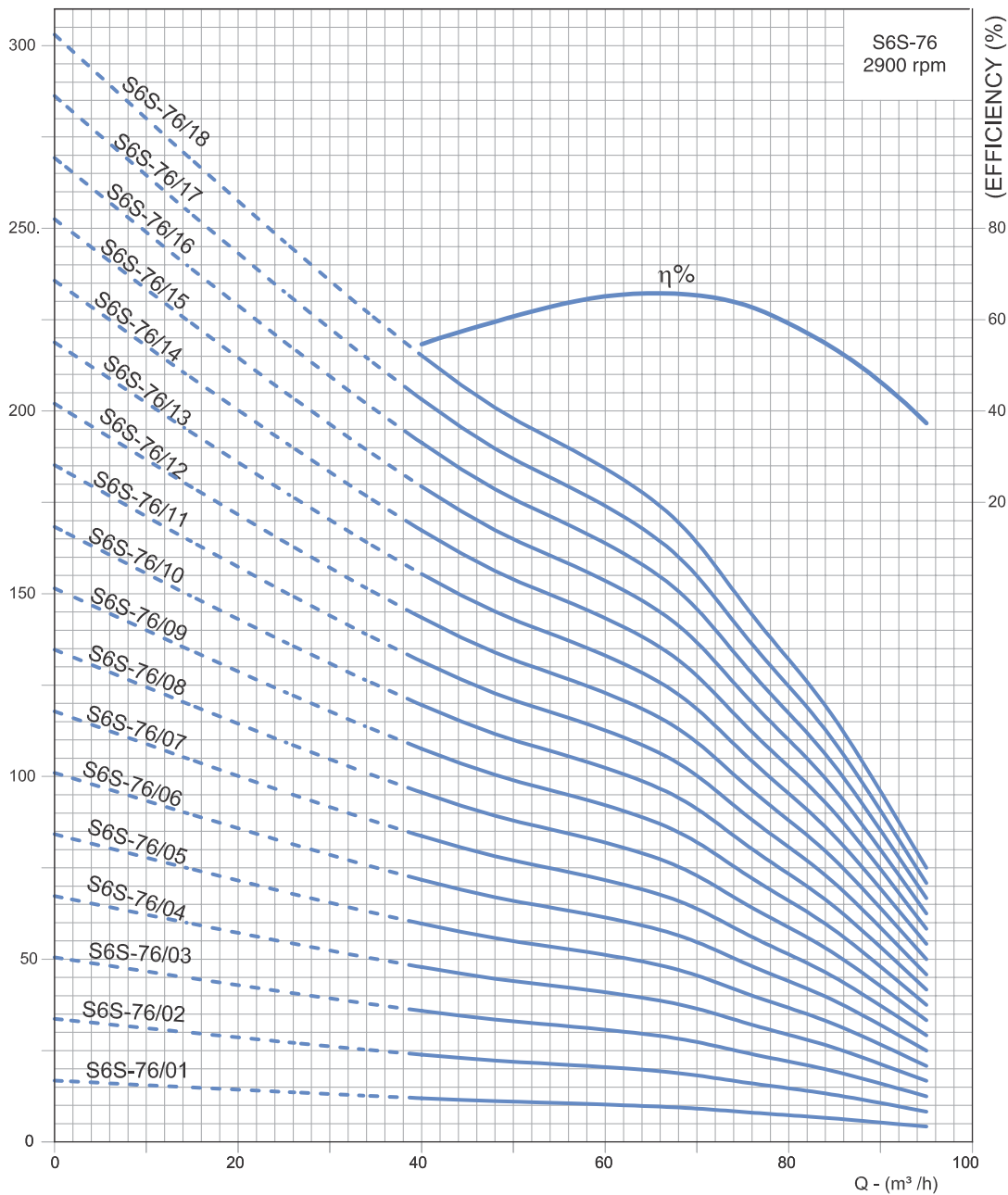

** Optional outlet Size.

In view of continuous developments, the informations / descriptions / specifications / illustrations are subject to change without notice. Refer general information for performance curve conditions and for other details. Curve tolerance according to ISO : 9906, Grade 3B

STAINLESS STEEL SERIES

Nominal Diameter : **6"**

Nominal Flow : **92m³/h**

Outlet Size : **3"/4"*****

Performance Table

DIMENSIONS & WEIGHT

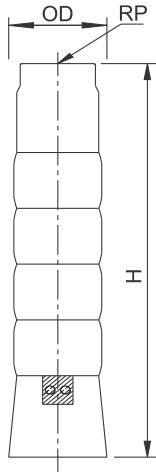

PUMP MODEL	REQUIRED MOTOR POWER		*NO OF CABLE GUARD	DIMENSIONS (mm)			APPROX NETT. WEIGHT (kg)
	kW	HP		#OD	RP	H	
S6S-92/01	4	5.5	1/2	149/153	100	457	11
S6S-92/02	7.5	10	1/2	149/153	100	601	14
S6S-92/03	11	15	1/2	149/153	100	745	17
S6S-92/04	15	20	1/2	149/153	100	889	20
S6S-92/05	18.5	25	1/2	149/153	100	1033	23
S6S-92/06	22	30	1/2	149/153	100	1177	26
S6S-92/07	26	35	1/2	149/153	100	1321	29
S6S-92/08	30	40	1/2	149/153	100	1465	32
S6S-92/09	37	50	1/2	149/153	100	1609	35
S6S-92/10	37	50	1/2	149/153	100	1753	38
S6S-92/11	45	60	1/2	149/153	100	1897	41
S6S-92/12	45	60	1/2	149/153	100	2041	44

PUMP MODEL	MOTOR kW	lps	0	20.8	23.6	25.0	26.4	27.8	29.2	30.6	31.9	33.3
		m ³ /h	0	75	85	90	95	100	105	110	115	120
S6S-92/01	4	TOTAL MANOMETRIC HEAD IN METRES - (COLUMN WATER)	15	10	10	10	9	8	7	6	5	4
S6S-92/02	7.5		29	21	20	19	18	16	14	12	11	8
S6S-92/03	11		44	31	30	29	27	24	21	19	16	13
S6S-92/04	15		58	41	39	38	36	32	28	25	21	17
S6S-92/05	18.5		73	52	49	48	45	40	35	31	27	21
S6S-92/06	22		87	62	59	57	54	48	42	37	32	25
S6S-92/07	26		102	72	69	67	63	56	49	43	37	29
S6S-92/08	30		116	83	79	76	72	64	56	49	43	33
S6S-92/09	37		131	93	89	86	81	72	63	56	48	38
S6S-92/10	37		145	103	98	95	90	80	70	62	53	42
S6S-92/11	45		160	114	108	105	99	88	77	68	59	46
S6S-92/12	45		174	124	118	114	108	96	84	74	64	50

* 1 denotes Single Cable Guard (D.O.L - 3 wire) and 2 denotes Double Cable Guard (S.D - 6 wire). Please specify preference, while placing order.

In view of continuous developments, the informations / descriptions / specifications / illustrations are subject to change without notice. Refer general information for performance curve conditions and for other details. Curve tolerance according to ISO : 9906, Grade 3B

STAINLESS STEEL SERIES

Nominal Diameter : **6"**

Nominal Flow : **92m³/h**

Outlet Size : **3"/4"*****

Performance Curves

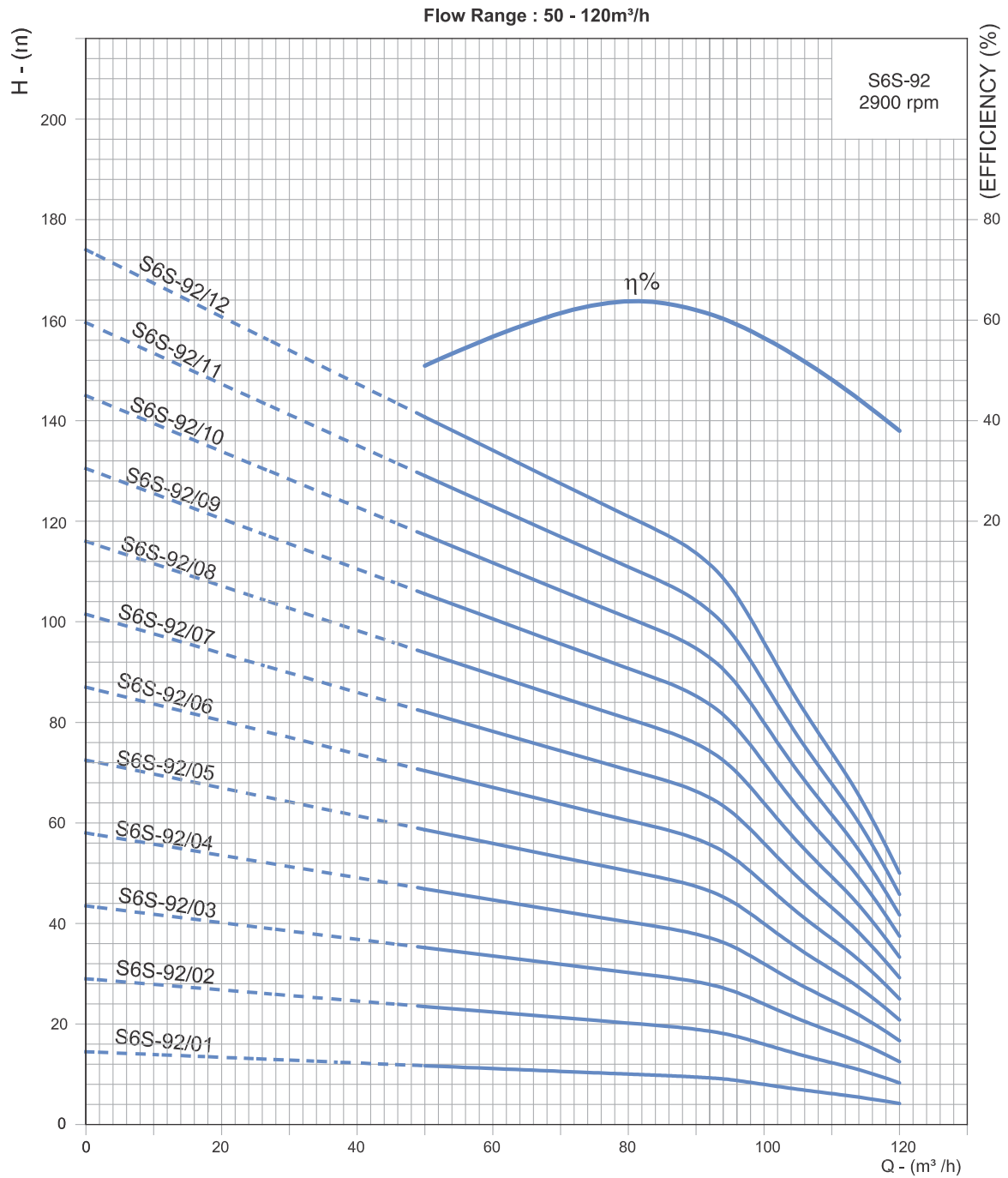

** Optional outlet Size.

In view of continuous developments, the informations / descriptions / specifications / illustrations are subject to change without notice. Refer general information for performance curve conditions and for other details. Curve tolerance according to ISO : 9906, Grade 3B

STAINLESS STEEL SERIES

Nominal Diameter : **8"**

Nominal Flow : **78m³/h**

Outlet Size : **4"/5"*****

Performance Table

DIMENSIONS & WEIGHT

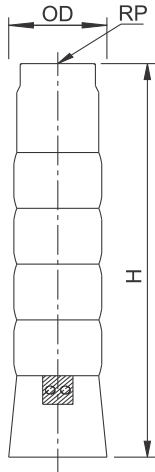

PUMP MODEL	REQUIRED MOTOR POWER		*NO OF CABLE GUARD	DIMENSIONS (mm)			APPROX NETT. WEIGHT (kg)
	kW	HP		#OD	RP	H	
S8S-78/01	5.5	7.5	1	193	100 / 125	554	22
S8S-78/02	7.5	10	1/2	193/195	100 / 125	682	26
S8S-78/03	11	15	1/2	193/195	100 / 125	810	29
S8S-78/04	15	20	1/2	193/195	100 / 125	938	33
S8S-78/05	18.5	25	1/2	193/195	100 / 125	1066	37
S8S-78/06	22	30	1/2	193/195	100 / 125	1194	41
S8S-78/07	26	35	1/2	193/195	100 / 125	1322	45
S8S-78/08	30	40	1/2	193/195	100 / 125	1450	48
S8S-78/09	30	40	1/2	193/195	100 / 125	1578	52
S8S-78/10	37	50	1/2	193/195	100 / 125	1706	56
S8S-78/11	45	60	1/2	193/195	100 / 125	1834	60
S8S-78/12	45	60	1/2	193/195	100 / 125	1962	63
S8S-78/13	55	75	1/2	193/195	100 / 125	2090	67
S8S-78/14	55	75	1/2	193/195	100 / 125	2218	71
S8S-78/15	55	75	1/2	193/196	100 / 126	2346	75
S8S-78/16	63	85	1/2	193/195	100 / 125	2474	78
S8S-78/17	63	85	1/2	193/195	100 / 125	2602	82
S8S-78/18	63	85	1/2	193/195	100 / 125	2730	85
S8S-78/19	75	100	1/2	193/195	100 / 125	2858	89
S8S-78/20	75	100	1/2	193/195	100 / 125	2986	93
S8S-78/21	75	100	1/2	193/195	100 / 125	3114	97
S8S-78/22	93	125	1/2	193/195	100 / 125	3242	100

OD for 8/8 - Combination of Motor & Pump

OD for 6/8 - Combination 173mm (single cable guard) 177mm (Double cable guard)

* 1 denotes Single Cable Guard (D.O.L - 3 wire) and 2 denotes Double Cable Guard (S.D - 6 wire). Please specify preference, while placing order.

In view of continuous developments, the informations / descriptions / specifications / illustrations are subject to change without notice. Refer general information for performance curve conditions and for other details. Curve tolerance according to ISO : 9906, Grade 3B

STAINLESS STEEL SERIES

Nominal Diameter : **8"**Nominal Flow : **78m³/h**Outlet Size : **4"/5"*****

Performance Table

PUMP MODEL	MOTOR kW	lps	0	5.56	8.34	11.11	13.88	16.66	22.22	27.78
		m ³ /h	0	20	30	40	50	60	80	100
S8S-78/01	5.5	TOTAL MANOMETRIC HEAD IN METRES - (COLUMN WATER)	20	19.7	18	16.8	15.5	14.2	12	7.5
S8S-78/02	7.5		39	38.5	37	34	31.5	29.5	24	15.5
S8S-78/03	11		59	59	55.5	51.5	47.5	43.7	34.5	22
S8S-78/04	15		81.5	80	76	70	65	59.5	48	31
S8S-78/05	18.5		102	99	94	87	80.5	75	60.5	37.5
S8S-78/06	22		121	118.5	112.5	104	96.5	89	72	44
S8S-78/07	26		142	138	131.5	122.5	112.5	103.5	84.5	72
S8S-78/08	30		162	157.5	150.5	139	128	118	96	58
S8S-78/09	30		182	177	167.5	155	143.5	132.5	107	64.5
S8S-78/10	37		202	197	188	174	160.5	148	120	74
S8S-78/11	45		218	217	207	191.5	177	163	132	78
S8S-78/12	45		244	237	225	209.5	192.5	178	145	89
S8S-78/13	55		265	258	245.5	228	211	194	157.5	94.5
S8S-78/14	55		285	277	263	245	226.5	209	169	101
S8S-78/15	55		304	300	285	264	243	224	184.5	111.5
S8S-78/16	63		323	316.5	300.5	280	259	239	195	119
S8S-78/17	63		343	336	319	297	274.5	253.5	205.5	125
S8S-78/18	63		357	355	339.5	317	292	269	218.5	133
S8S-78/19	75		381	376	357.5	332.5	308	284	230	141.5
S8S-78/20	75		404	395	375	346	322	297	242	150
S8S-78/21	75		420	410	390	368	335	309	250	157
S8S-78/22	93		440	429	407	380	350	324	265	164

** Optional outlet Size.

In view of continuous developments, the informations / descriptions / specifications / illustrations are subject to change without notice. Refer general information for performance curve conditions and for other details. Curve tolerance according to ISO : 9906, Grade 3B

STAINLESS STEEL SERIES

Nominal Diameter : **8"**

Nominal Flow : **78m³/h**

Outlet Size : **4"/5"*****

Performance Curves

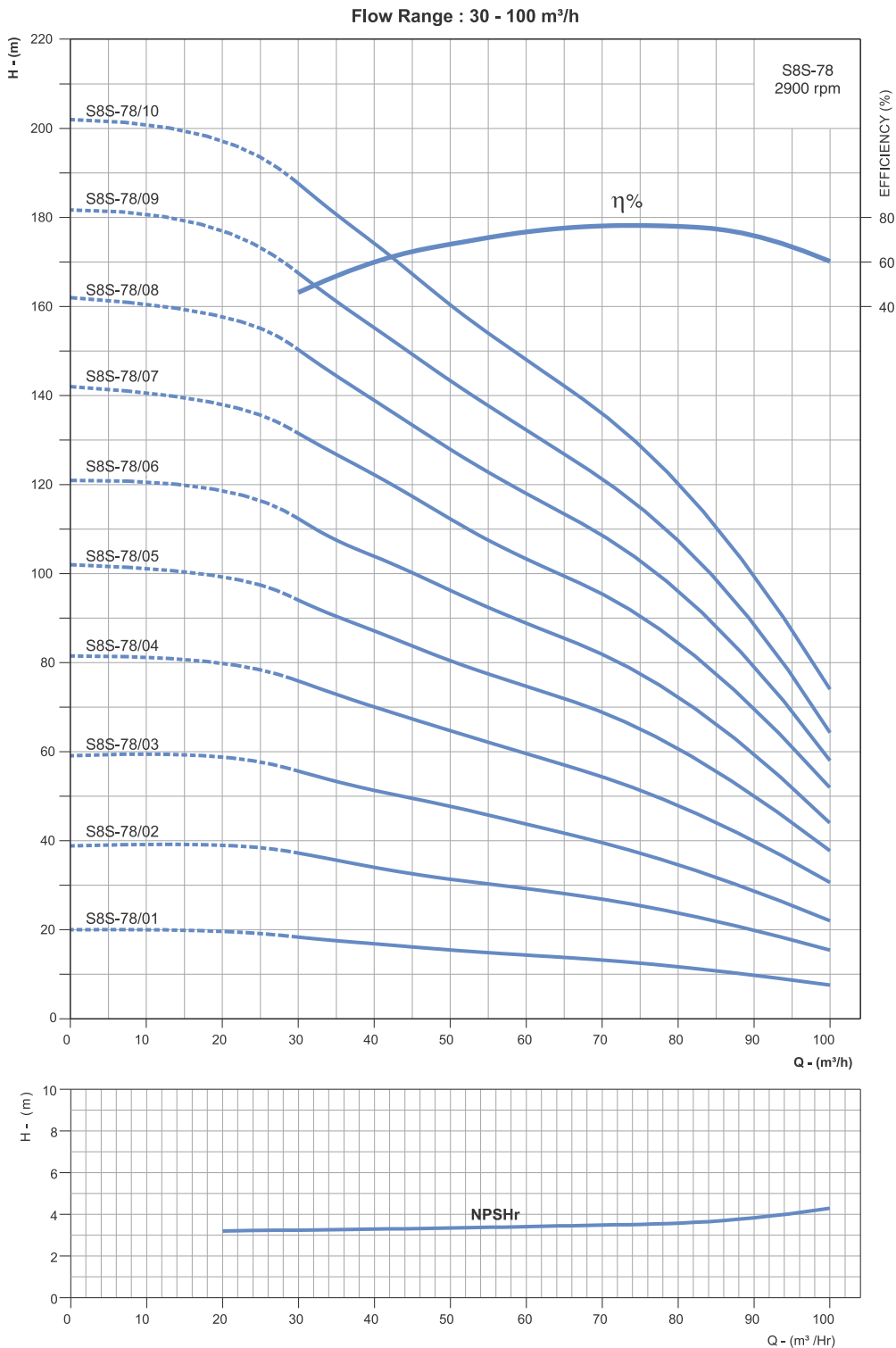

** Optional outlet Size.

In view of continuous developments, the informations / descriptions / specifications / illustrations are subject to change without notice. Refer general information for performance curve conditions and for other details. Curve tolerance according to ISO : 9906, Grade 3B

STAINLESS STEEL SERIES

Nominal Diameter : **8"**

Nominal Flow : **78m³/h**

Outlet Size : **4"/5"*****

Performance Curves

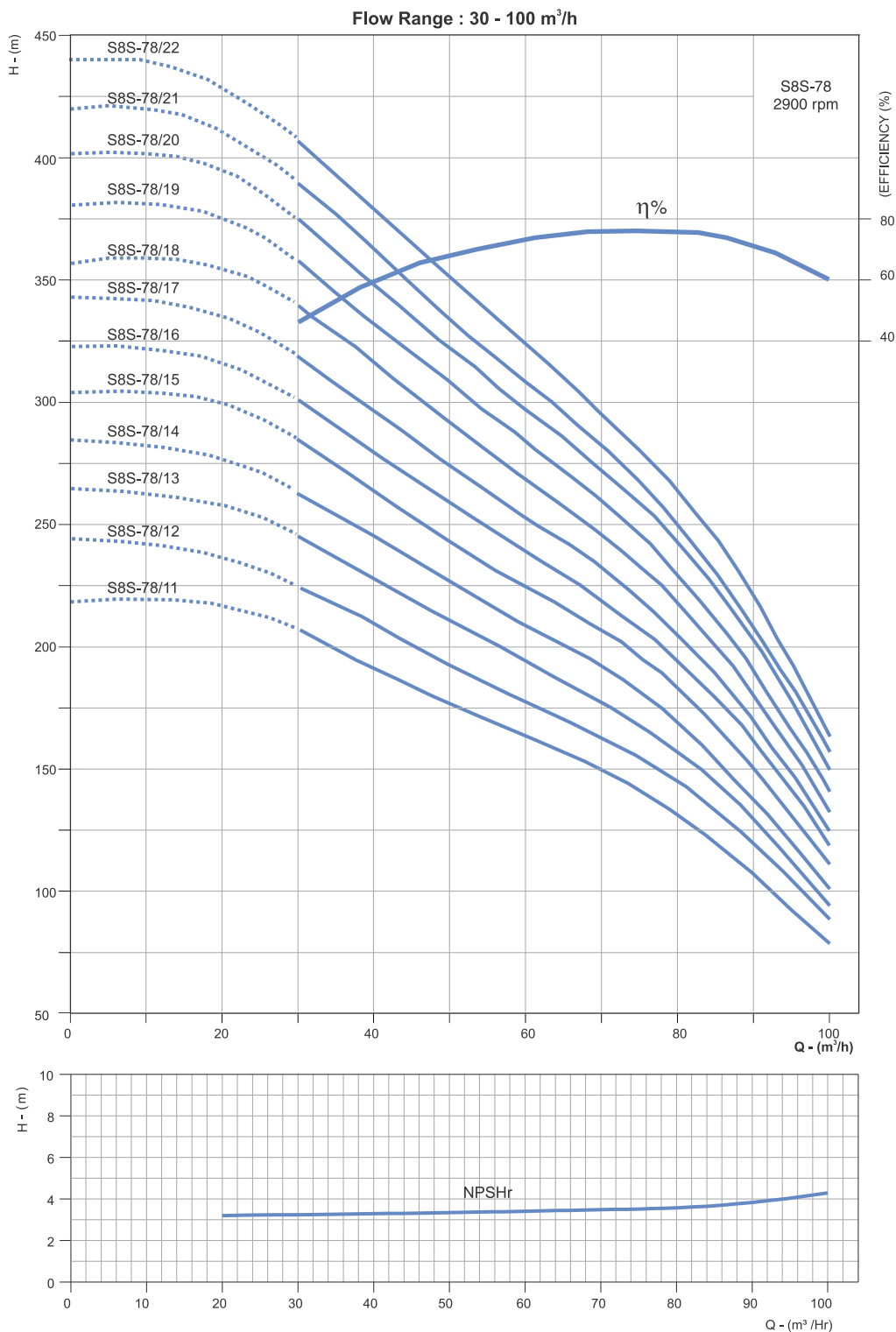

** Optional outlet Size.

In view of continuous developments, the informations / descriptions / specifications / illustrations are subject to change without notice. Refer general information for performance curve conditions and for other details. Curve tolerance according to ISO : 9906, Grade 3B

STAINLESS STEEL SERIES

Nominal Diameter : **8"**

Nominal Flow : **95m³/h**

Outlet Size : **5"**

Performance Table

DIMENSIONS & WEIGHT

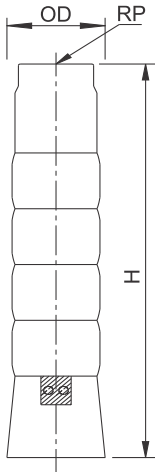

PUMP MODEL	REQUIRED MOTOR POWER		*NO OF CABLE GUARD	DIMENSIONS (mm)			APPROX NETT. WEIGHT (kg)
	kW	HP		#OD	RP	H	
S8S-95/01	5.5	7.5	1	193	125	554	22
S8S-95/02	9.3	12.5	1/2	193/195	125	682	26
S8S-95/03	13	17.5	1/2	193/195	125	810	30
S8S-95/04	18.5	25	1/2	193/195	125	938	33
S8S-95/05	22	30	1/2	193/195	125	1066	37
S8S-95/06	26	35	1/2	193/195	125	1194	41
S8S-95/07	30	40	1/2	193/195	125	1322	45
S8S-95/08	37	50	1/2	193/195	125	1450	49
S8S-95/09	37	50	1/2	193/195	125	1578	53
S8S-95/10	45	60	1/2	193/195	125	1706	57
S8S-95/11	55	75	1/2	193/195	125	1834	61
S8S-95/12	55	75	1/2	193/195	125	1962	64
S8S-95/13	55	75	1/2	193/195	125	2090	68
S8S-95/14	63	85	1/2	193	25	2218	74
S8S-95/15	75	100	1/2	193/195	125	2346	76
S8S-95/16	75	100	1/2	193/196	125	2474	80
S8S-95/17	93	125	1/2	193/197	125	2602	84
S8S-95/18	93	125	1/2	193/198	125	2730	88
S8S-95/19	93	125	1/2	193/199	125	2858	92
S8S-95/20	93	125	1/2	193/200	125	2986	96
S8S-95/22	110	150	1/2	193/195	125	3242	104
S8S-95/24	130	175	1/2	193/195	125	3370	111

OD for 8/8 combination of motor & pump
 OD for 6/8 combination 173mm (Single cable guard) 177mm (Double cable guard)

* 1 denotes Single Cable Guard (D.O.L - 3 wire) and 2 denotes Double Cable Guard (S.D - 6 wire). Please specify preference, while placing order.

In view of continuous developments, the informations / descriptions / specifications / illustrations are subject to change without notice. Refer general information for performance curve conditions and for other details. Curve tolerance according to ISO : 9906, Grade 3B

STAINLESS STEEL SERIES

Nominal Diameter : **8"**Nominal Flow : **95m³/h**Outlet Size : **5"**

Performance Table

PUMP MODEL	MOTOR kW	lps	0	5.56	11.11	16.66	22.22	27.78	33.33	35
		m ³ /h	0	20	40	60	80	100	120	126
S8S-95/01	5.5	TOTAL MANOMETRIC HEAD IN METRES - (COLUMN WATER)	22	21	18	15.5	13.5	11.5	6	2
S8S-95/02	9.3		44	41.5	36	31.5	28	22.5	13	8.5
S8S-95/03	13		68	62.5	55.3	48.5	42.5	32.5	19.5	12.5
S8S-95/04	18.5		90	83.5	74	65	56.5	44	26	17
S8S-95/05	22		111	103	93	80.5	70.5	55.5	33	24
S8S-95/06	26		131	124	111.5	97	84.5	67	40	29
S8S-95/07	30		151	144	129.5	113	98	78	47	34.5
S8S-95/08	37		173	165	148.5	130	114	91.5	54.5	40
S8S-95/09	37		194	184	165.5	144	126	100.5	60.5	47
S8S-95/10	45		211	200	181.5	162	140	113	68.5	51
S8S-95/11	55		237.5	227.5	204.5	179.5	158	126.5	77	60.5
S8S-95/12	55		262.5	248	222	194.5	170	137.5	83	64
S8S-95/13	55		285	268	241.5	210.5	185.5	151	90.5	69
S8S-95/14	63		306	291	262	229.5	202	164.5	100	78
S8S-95/15	75		326	310	280	246	216	176	106.5	57
S8S-95/16	75		347.5	331	296.5	261	229	186	112.5	89.5
S8S-95/17	75		367.5	350	314	275.5	241.5	196	119	95
S8S-95/18	93		393	373	336	294	259	211	128	99
S8S-95/19	93		410	391.5	355	310.5	274	220	133	105
S8S-95/20	93		435	416	376.5	325.5	286	231.5	145	112
S8S-95/22	110	475	452	416.5	351	307	250	156	120	
S8S-95/24	130	518	490	453	383	332	270	176	132	

STAINLESS STEEL SERIES

Nominal Diameter : **8"**

Nominal Flow : **95m³/h**

Outlet Size : **5"**

Performance Curves

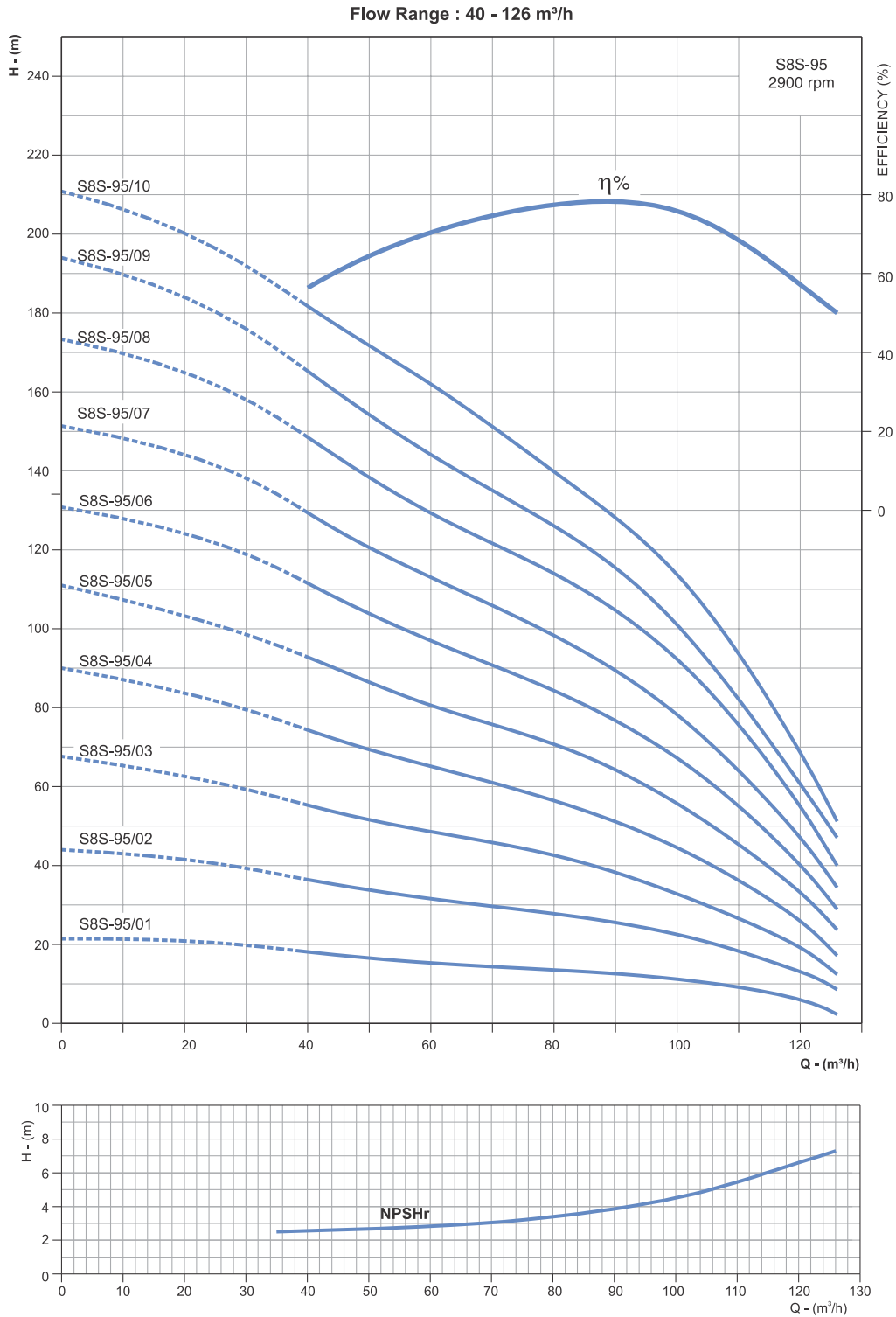

In view of continuous developments, the informations / descriptions / specifications / illustrations are subject to change without notice. Refer general information for performance curve conditions and for other details. Curve tolerance according to ISO : 9906, Grade 3B

STAINLESS STEEL SERIES

Nominal Diameter : **8"**

Nominal Flow : **95m³/h**

Outlet Size : **5"**

Performance Curves

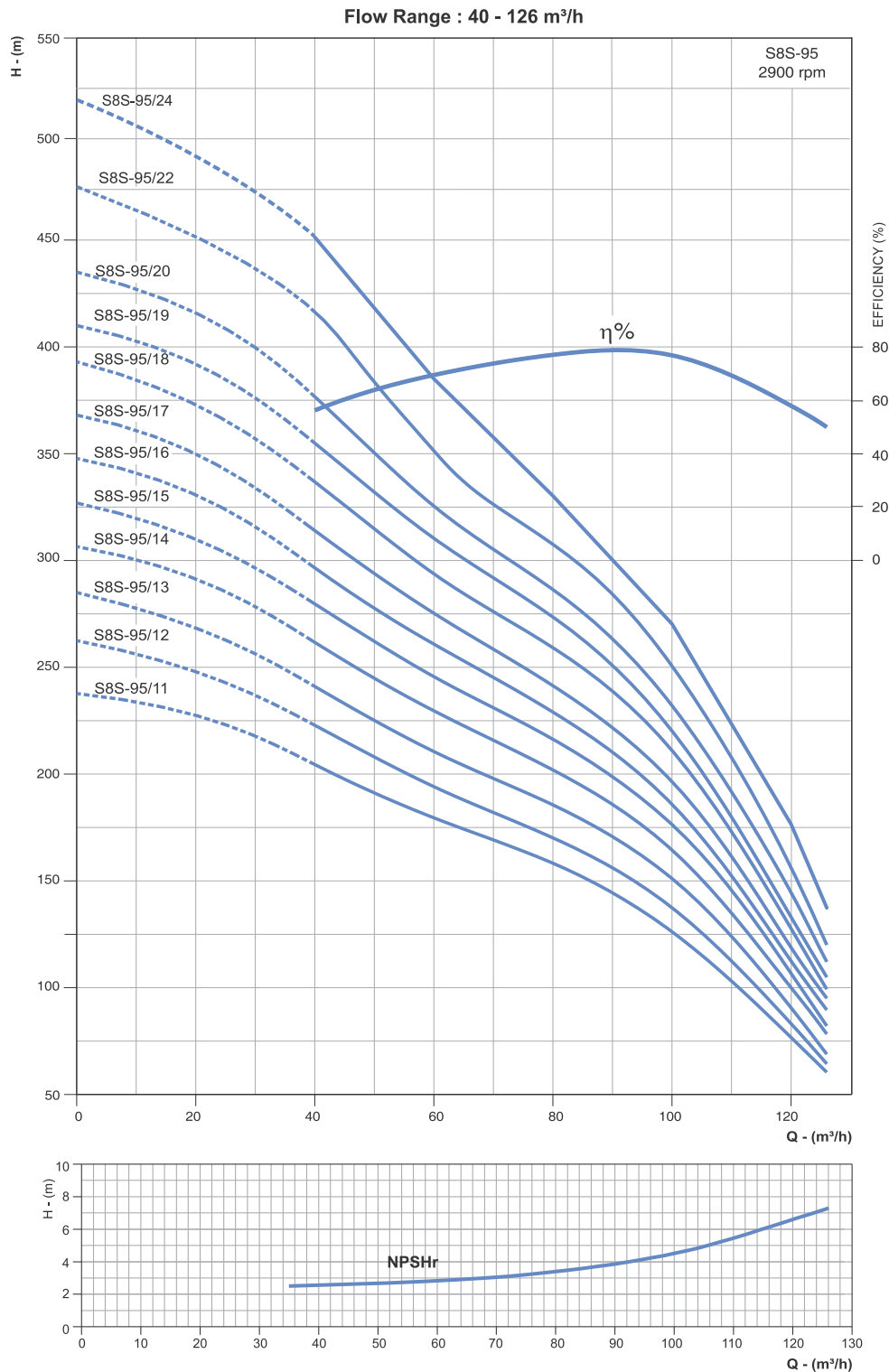

In view of continuous developments, the informations / descriptions / specifications / illustrations are subject to change without notice. Refer general information for performance curve conditions and for other details. Curve tolerance according to ISO : 9906, Grade 3B

STAINLESS STEEL SERIES

Nominal Diameter : **10"**

Nominal Flow : **125m³/h**

Outlet Size : **6"**

Performance Table

DIMENSIONS & WEIGHT

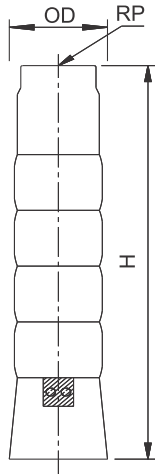

PUMP MODEL	REQUIRED MOTOR POWER		*No. OF CABLE GUARD	DIMENSIONS (mm)			APPROX NETT. WEIGHT (kg)
	kW	HP		#OD	RP	H	
S10S-125/01	11	15	1/2	225	150	644	31
S10S-125/02	22	30	1/2	225	150	798	37
S10S-125/03	30	40	1/2	225	150	952	43
S10S-125/04R	37	50	1/2	225	150	1106	49
S10S-125/04	45	60	1/2	225	150	1106	49
S10S-125/05R	45	60	1/2	225	150	1260	55
S10S-125/05	55	75	1/2	225	150	1260	55
S10S-125/06	63	85	1/2	225	150	1414	61
S10S-125/07	75	100	1/2	225	150	1568	67
S10S-125/08RR	75	100	1/2	225	150	1722	74
S10S-125/08R	75	100	1/2	225	150	1722	74
S10S-125/08	75	100	1/2	225	150	1722	74
S10S-125/09	93	125	1/2	225	150	1876	80
S10S-125/10R	93	125	1/2	225	150	2030	86
S10S-125/10	93	125	1/2	225	150	2030	86

PUMP MODEL	MOTOR kW	lps	0	13.88	20.83	27.77	34.72	41.66	45
		m ³ /h	0	50	75	100	125	150	162
S10S-125/01	11	TOTAL MANOMETRIC HEAD IN METRES - (COLUMN WATER)	29	26	24	21	18	14	12
S10S-125/02	22		58	56	49	44	38	30	25
S10S-125/03	30		86	81	74	66	56	45	37
S10S-125/04R	37		105	100	92	83	70	52	43
S10S-125/04	45		114	108	99	90	78	60	50
S10S-125/05R	45		135	129	119	108	93	70	58
S10S-125/05	55		144	134	127	116	102	80	68
S10S-125/06	63		174	166	154	140	123	97	93
S10S-125/07	75		202	194	180	164	144	114	97
S10S-125/08RR	75		213	204	190	172	148	114	94
S10S-125/08R	75		220	212	194	176	152	117	97
S10S-125/08	75		228	219	202	183	160	124	106
S10S-125/09	93		259	238	228	208	182	142	122
S10S-125/10R	93		279	268	247	226	195	152	127
S10S-125/10	93		287	274	254	231	204	158	132

OD for all combination of motor & pump (204mm - Single cable guard, 207 mm - Double cable guard)

* 1 denotes Single Cable Guard (D.O.L - 3 wire) and 2 denotes Double Cable Guard (S.D - 6 wire). Please specify preference, while placing order.

** In pump models last digit R denotes reduced impeller OD and RR denotes further reduced impeller OD

In view of continuous developments, the informations / descriptions / specifications / illustrations are subject to change without notice. Refer general information for performance curve conditions and for other details. Curve tolerance according to ISO : 9906, Grade 3B

STAINLESS STEEL SERIES

Nominal Diameter : **10"**

Nominal Flow : **125m³/h**

Outlet Size : **6"**

Performance Curves

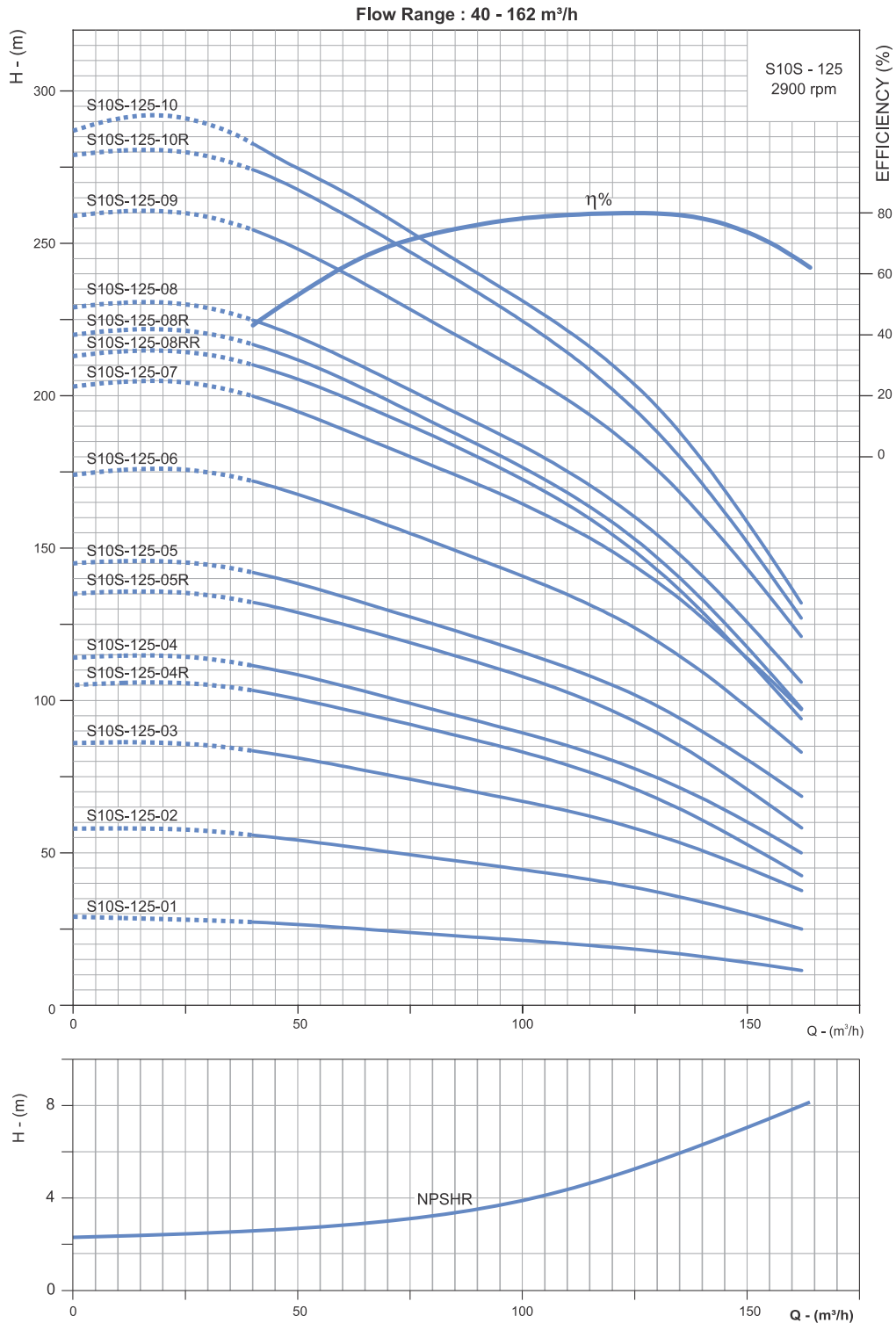

In view of continuous developments, the informations / descriptions / specifications / illustrations are subject to change without notice. Refer general information for performance curve conditions and for other details. Curve tolerance according to ISO : 9906, Grade 3B

STAINLESS STEEL SERIES

Nominal Diameter : **10"**

Nominal Flow : **125m³/h**

Outlet Size : **6"**

Performance Table

DIMENSIONS & WEIGHT

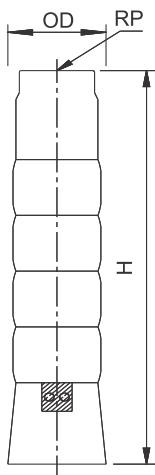

PUMP MODEL	REQUIRED MOTOR POWER		*No. OF CABLE GUARD	DIMENSIONS (mm)			APPROX NETT. WEIGHT (kg)
	kW	HP		#OD	RP	H	
S10S-125/11	110	150	1/2	225	150	2184	92
S10S-125/12	132	175	1/2	225	150	2338	98
S10S-125/13	132	175	1/2	225	150	2492	109
S10S-125/14	150	200	1/2	225	150	2646	120
S10S-125/15	150	200	1/2	225	150	2800	131
S10S-125/16	170	225	1/2	225	150	2954	142
S10S-125/17	170	225	1/2	225	150	3108	152

PUMP MODEL	MOTOR kW	TOTAL MANOMETRIC HEAD IN METRES (COLUMN WATER)	lps	0	13.88	20.83	27.77	34.72	41.66	45
			m ³ /h	0	50	75	100	125	150	162
S10S-125/11	110		308	300	274	249	219	170	140	
S10S-125/12	132		343	330	305	278	246	192	162	
S10S-125/13	132		372	358	328	299	264	210	177	
S10S-125/14	150		400	390	360	328	292	232	192	
S10S-125/15	150		426	416	384	351	310	248	209	
S10S-125/16	170		456	443	410	376	330	265	225	
S10S-125/17	170		488	473	440	400	352	286	240	

OD for all combination of motor & pump (204mm - Single cable guard, 207 mm - Double cable guard)

* 1 denotes Single Cable Guard (D.O.L - 3 wire) and 2 denotes Double Cable Guard (S.D - 6 wire). Please specify preference, while placing order.

** In pump models last digit R denotes reduced impeller OD and RR denotes further reduced impeller OD

In view of continuous developments, the informations / descriptions / specifications / illustrations are subject to change without notice. Refer general information for performance curve conditions and for other details. Curve tolerance according to ISO : 9906, Grade 3B

STAINLESS STEEL SERIES

Nominal Diameter : **10"**

Nominal Flow : **125m³/h**

Outlet Size : **6"**

Performance Curves

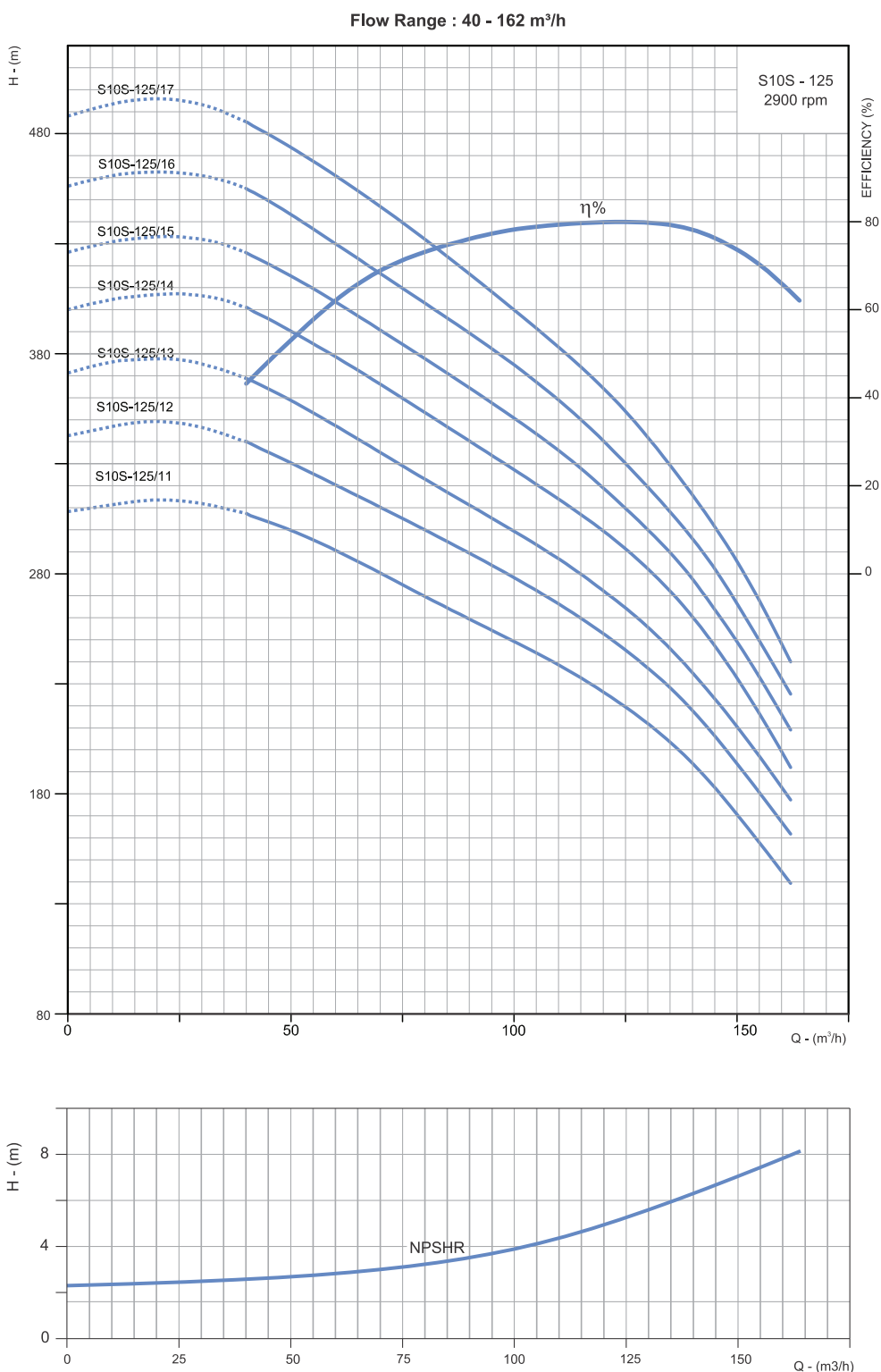

In view of continuous developments, the informations / descriptions / specifications / illustrations are subject to change without notice. Refer general information for performance curve conditions and for other details. Curve tolerance according to ISO : 9906, Grade 3B

STAINLESS STEEL SERIES

Nominal Diameter : **10"**

Nominal Flow : **160m³/h**

Outlet Size : **6"**

Performance Table

DIMENSIONS & WEIGHT

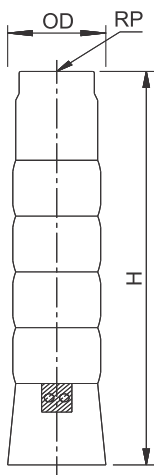

PUMP MODEL	REQUIRED MOTOR POWER		*No. OF CABLE GUARD	DIMENSIONS (mm)			APPROX NETT. WEIGHT (kg)
	kW	HP		#OD	RP	H	
S10S - 160/01R	9.3	12.5	1/2	225	150	646	30
S10S - 160/01	13	18.5	1/2	225	150	646	30
S10S - 160/02RR	18.5	25	1/2	225	150	802	36
S10S - 160/02R	22	30	1/2	225	150	802	36
S10S - 160/02	26	35	1/2	225	150	802	36
S10S - 160/03RR	30	40	1/2	225	150	958	43
S10S - 160/03R	37	50	1/2	225	150	958	43
S10S - 160/03	37	50	1/2	225	150	958	43
S10S - 160/04RR	45	60	1/2	225	150	1114	49
S10S - 160/04R	45	60	1/2	225	150	1114	49
S10S - 160/04	55	75	1/2	225	150	1114	49
S10S - 160/05RR	55	75	1/2	225	150	1270	56
S10S - 160/05R	55	75	1/2	225	150	1270	56
S10S - 160/05	63	85	1/2	225	150	1270	56
S10S - 160/06RR	63	85	1/2	225	150	1426	62
S10S - 160/06R	75	100	1/2	225	150	1426	62
S10S - 160/06	75	100	1/2	225	150	1426	62
S10S - 160/07RR	75	100	1/2	225	150	1582	68
S10S - 160/07R	93	125	1/2	225	150	1582	68
S10S - 160/07	93	125	1/2	225	150	1582	68
S10S - 160/08RR	93	125	½	225	150	1738	74
S10S - 160/08R	93	125	1/2	225	150	1738	74
S10S - 160/08	93	125	1/2	225	150	1738	74
S10S - 160/09RR	110	150	1/2	225	150	1894	83
S10S - 160/09R	110	150	1/2	225	150	1894	83
S10S - 160/09	110	150	1/2	225	150	1894	83
S10S - 160/10RR	110	150	1/2	225	150	2050	90
S10S - 160/10R	132	175	1/2	225	150	2050	90
S10S - 160/10	132	175	1/2	225	150	2050	90
S10S - 160/11	132	175	1/2	225	150	2206	96
S10S - 160/12	150	200	1/2	225	150	2362	107
S10S - 160/13	170	225	1/2	225	150	2518	113
S10S - 160/14	170	225	1/2	225	150	2674	119
S10S - 160/15	187	250	1/2	225	150	2830	125

OD for all combination motor & pump. (208 mm - Single cable guard, 211 mm - Double cable guard).

* 1 denotes Single Cable Guard (D.O.L - 3 wire) and 2 denotes Double Cable Guard (S.D - 6 wire). Please specify preference, while placing order.

** In pump model last digit R denotes reduced impeller O.D and RR denotes further reduced impeller O.D.

In view of continuous developments, the informations / descriptions / specifications / illustrations are subject to change without notice. Refer general information for performance curve conditions and for other details. Curve tolerance according to ISO : 9906, Grade 3B

STAINLESS STEEL SERIES

Nominal Diameter : **10"**Nominal Flow : **160m³/h**Outlet Size : **6"**

Performance Table

PUMP MODEL	MOTOR kW	lps	0	13.89	22.24	33.36	44.48	55.6
		m ³ /hr	0	50	80	120	160	200
S10S - 160/1R	9.3	TOTAL MANOMETRIC HEAD IN METRES - (COLUMN WATER)	25	22	20.5	17	13	6
S10S - 160/1	13		33	30	26.5	23	20	14.5
S10S - 160/2RR	18.5		48	44	39	34	27	14
S10S - 160/2R	22		55	52	47	40	33	20.5
S10S - 160/2	26		61	60	54	46	39	27
S10S - 160/3RR	30		77	75	69	59	47	28
S10S - 160/3R	37		87.5	84	76	65	55	36
S10S - 160/3	37		95.5	91	80.5	70	60	41
S10S - 160/4RR	45		111	106	96	83	70	44
S10S - 160/4R	45		117	114	103	88.5	76	50
S10S - 160/4	55		124.5	120	110	95	80	59
S10S - 160/5RR	55		140	186	123	107	90	59.5
S10S - 160/5R	55		148	144	129	111	95	64
S10S - 160/5	63		155	150	136.5	118	100	71
S10S - 160/6RR	63		169	163	150	129	108.5	72
S10S - 160/6R	75		177	170	155	135	113	76
S10S - 160/6	75		186	180	165	142	119	84
S10S - 160/7RR	75		200	193	177	153	127	86
S10S - 160/7R	93		208	203	184	159	136	92
S10S - 160/7	93		220	209	188.5	163	138	96
S10S - 160/8RR	93		230	223	203	175	147	97
S10S - 160/8R	93		240	231	209	180	153	104
S10S - 160/8	93		247.5	239	216	188.5	156.5	108
S10S - 160/9RR	110		255	251	229	193	160	105
S10S - 160/9R	110		265	263	238	200	167	112
S10S - 160/9	110		275	273	249	207	176	120
S10S - 160/10RR	110		294	283	260	218	185	178
S10S - 160/10R	132		304	289	270	228	195	138
S10S - 160/10	132		310	300	280	233	200	140
S10S - 160/11	132		333	328	309	255	220	156
S10S - 160/12	150	360	358	338	279	235	173	
S10S - 160/13	170	392	389	362	304	255	190	
S10S - 160/14	170	423	418	389	324	274	208	
S10S - 160/15	187	453	450	419	350	292	220	

STAINLESS STEEL SERIES

Nominal Diameter : **10"**

Nominal Flow : **160m³/h**

Outlet Size : **6"**

Performance Curves

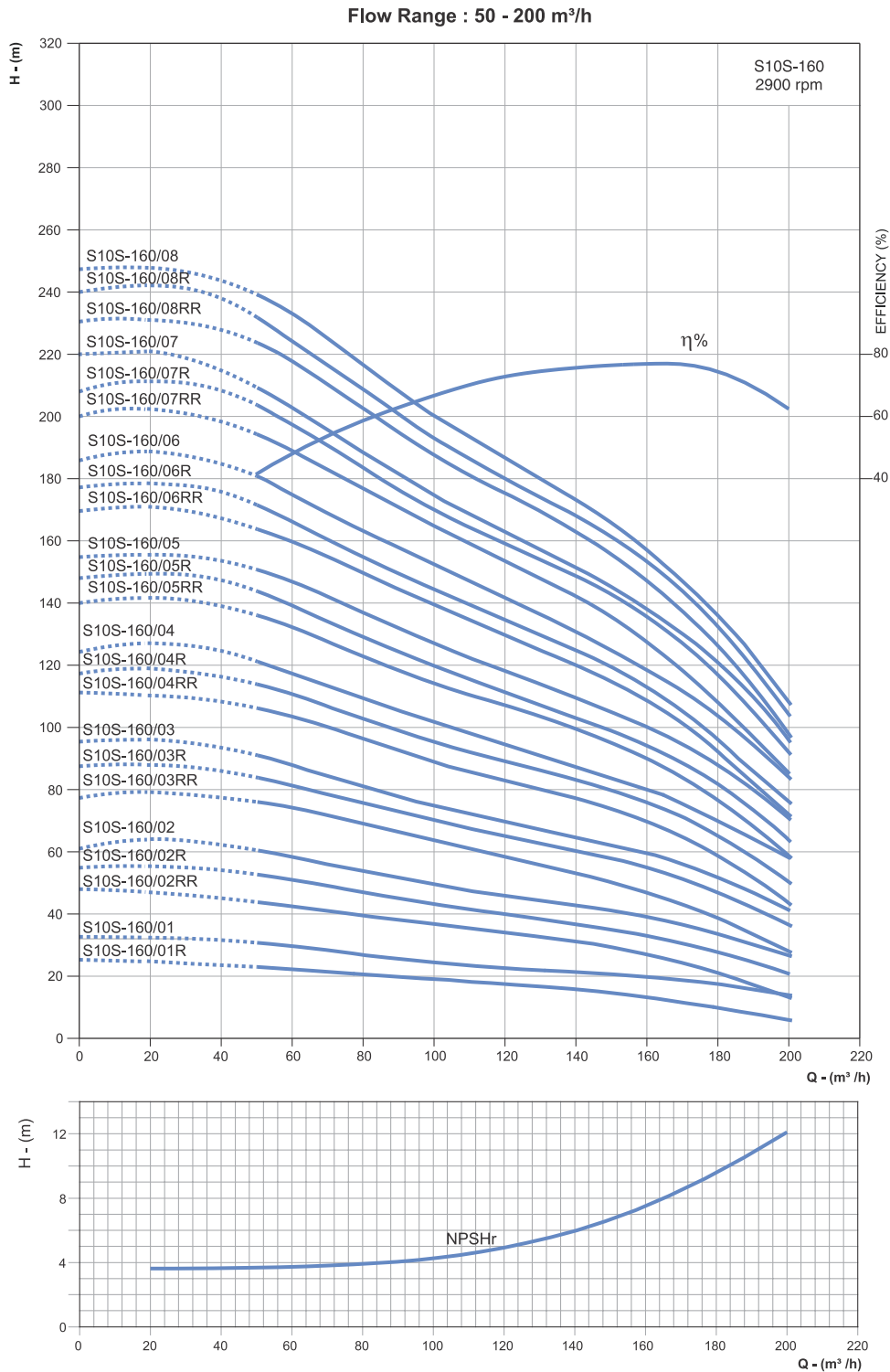

In view of continuous developments, the informations / descriptions / specifications / illustrations are subject to change without notice. Refer general information for performance curve conditions and for other details. Curve tolerance according to ISO : 9906, Grade 3B

STAINLESS STEEL SERIES

Nominal Diameter : **10"**

Nominal Flow : **160m³/h**

Outlet Size : **6"**

Performance Curves

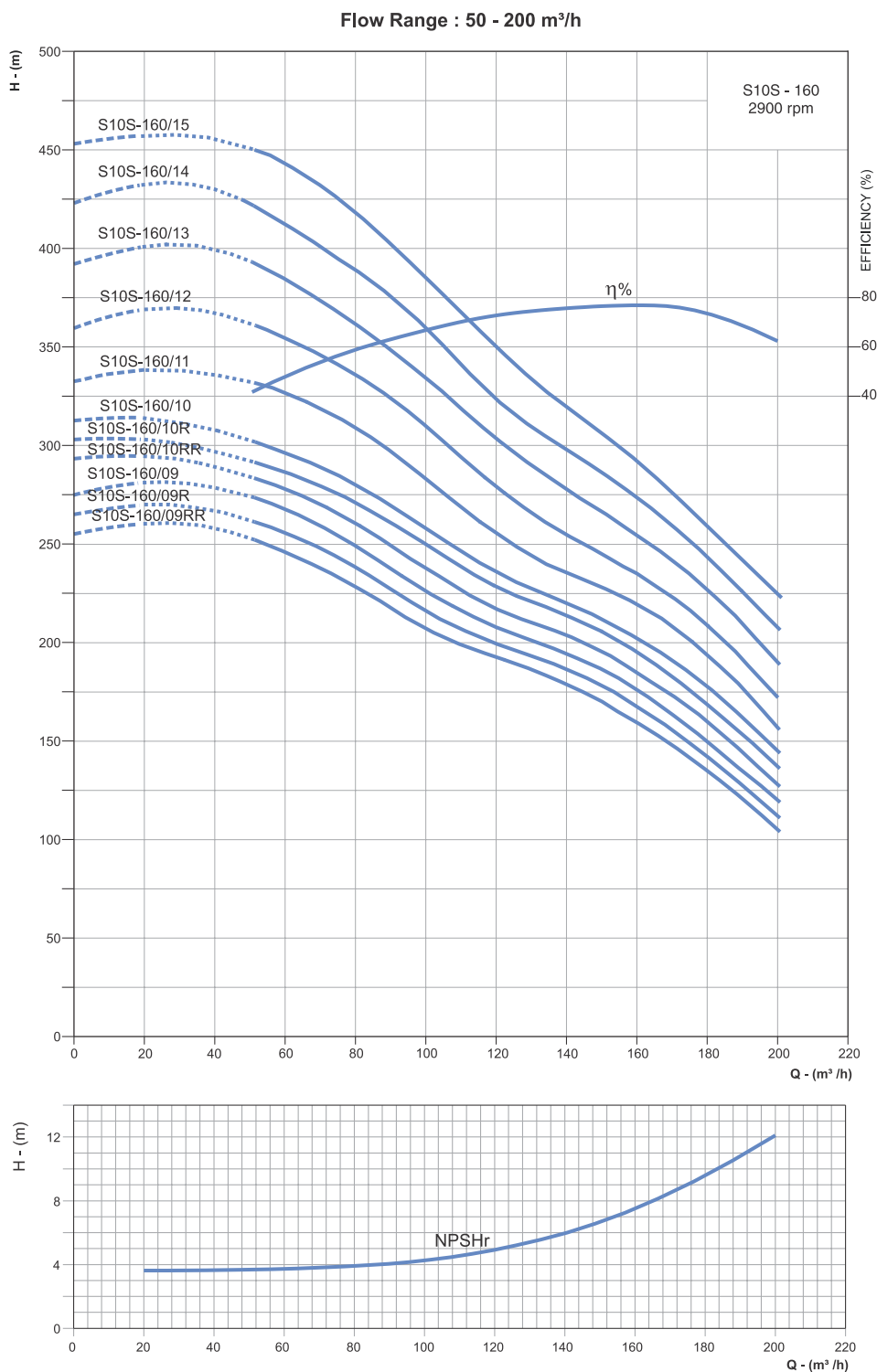

In view of continuous developments, the informations / descriptions / specifications / illustrations are subject to change without notice. Refer general information for performance curve conditions and for other details. Curve tolerance according to ISO : 9906, Grade 3B

STAINLESS STEEL SERIES

Nominal Diameter : **10"**

Nominal Flow : **215m³/h**

Outlet Size : **6"**

Performance Table

DIMENSIONS & WEIGHT

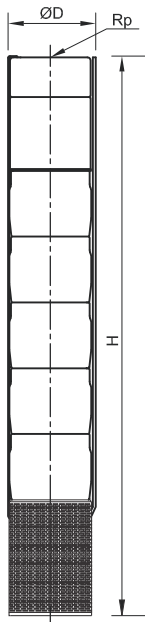

PUMP MODEL	REQUIRED MOTOR POWER		*No. OF CABLE GUARD	DIMENSIONS (mm)			APPROX NETT. WEIGHT (kg)	
	kW	HP		OD*	RP	H		
S10S - 215/1R	15	20	1/2	247	255	150	794	47
S10S - 215/1	18.5	25	1/2	247	255	150	794	47
S10S - 215/2RR	30	40	1/2	247	255	150	670	60
S10S - 215/2R	37	50	1/2	247	255	150	670	60
S10S - 215/2	45	60	1/2	247	255	150	670	60
S10S - 215/3RR	55	75	1/2	247	255	150	1146	80
S10S - 215/3R	55	75	1/2	247	255	150	1146	80
S10S - 215/3	63	85	1/2	247	255	150	1146	80
S10S - 215/4RR	75	100	1/2	247	255	150	1322	92
S10S - 215/4R	75	100	1/2	247	255	150	1322	92
S10S - 215/4	75	100	1/2	247	255	150	1322	92
S10S - 215/5RR	93	125	1/2	247	255	150	1498	105
S10S - 215/5R	93	125	1/2	247	255	150	1498	105
S10S - 215/5	93	125	1/2	247	255	150	1498	105
S10S - 215/6RR	110	150	1/2	247	255	150	1674	117
S10S - 215/6R	110	150	1/2	247	255	150	1674	117
S10S - 215/6	110	150	1/2	247	255	150	1674	117
S10S - 215/7RR	130	175	1/2	247	255	150	1850	130
S10S - 215/7R	130	175	1/2	247	255	150	1850	130
S10S - 215/7	130	175	1/2	247	255	150	1850	130
S10S - 215/8RR	150	200	1/2	247	255	150	2026	142
S10S - 215/8R	150	200	1/2	247	255	150	2026	142
S10S - 215/8	150	200	1/2	247	255	150	2026	142
S10S - 215/9RR	170	225	1/2	247	255	150	2202	155
S10S - 215/9R	170	225	1/2	247	255	150	2202	155
S10S - 215/9	170	225	1/2	247	255	150	2202	155
S10S - 215/10RR	187	250	1/2	247	255	150	2378	167
S10S - 215/10R	187	250	1/2	247	255	150	2378	167
S10S - 215/10	187	250	1/2	247	255	150	2378	167
S10S - 215/11	220	300	1/2	247	255	150	2554	180

OD for all combinations of motor & pump. (247mm - Single Cable Guard. 255mm - Double Cable Guard)

* 1 denotes Single Cable Guard (D.O.L - 3 wire) and 2 denotes Double Cable Guard (S.D - 6 wire). Please specify preference, while placing order.

** In pump model last digit R denotes reduced impeller OD and RR denotes further reduced impeller OD

In view of continuous developments, the informations / descriptions / specifications / illustrations are subject to change without notice. Refer general information for performance curve conditions and for other details. Curve tolerance according to ISO : 9906, Grade 3B

STAINLESS STEEL SERIES

Nominal Diameter : **10"**Nominal Flow : **215m³/h**Outlet Size : **6"**

Performance Table

PUMP MODEL	MOTOR POWER		lps	0	13.89	27.78	41.67	55.56	59.72	69.44	77.78
	kW	HP	m ³ /h	0	50	100	150	200	215	250	280
S10S - 215/1R	15	20	TOTAL MANOMETRIC HEAD IN METRES - (COLUMN WATER)	26	25	23	19	15	13	7	4
S10S - 215/1	18.5	25		38	36	32	27	23.5	22	16.5	10.5
S10S - 215/2RR	30	40		53	52	49	42	35	31	21	11
S10S - 215/2R	37	50		64	61	55	49	42	40	30	18
S10S - 215/2	45	60		82	76	68	58	50	48	41	29.50
S10S - 215/3RR	55	75		90	88	80	71	61	58	43	24
S10S - 215/3R	55	75		101	97	88	76	66	63	49	33
S10S - 215/3	63	85		120	112	102	87	74	70	56	32
S10S - 215/4RR	75	100		127	125	114	101	86	81	64	40
S10S - 215/4R	75	100		138	134	121	106	92	87	70	48
S10S - 215/4	75	100		156	147	137	120	102	97	80	52
S10S - 215/5RR	93	125		165	161	146	129	111	105	83	55
S10S - 215/5R	93	125		175	170	153	134	118	110	89	63
S10S - 215/5	93	125		196	185	172	150	128	123	100	69
S10S - 215/6RR	110	150		201	196	178	156	136	128	101	70
S10S - 215/6R	110	150		212	206	186	163	141	134	109	78
S10S - 215/6	110	150		225	218	195	170	148	140	115	86
S10S - 215/7RR	130	175		242	236	214	189	165	156	126	90
S10S - 215/7R	130	175		252	246	222	195	171	162	33	99
S10S - 215/7	130	175		267	258	232	203	178	169	140	107
S10S - 215/8RR	150	200		281	273	248	218	191	181	148	106
S10S - 215/8R	150	200	286	282	255	225	197	186	153	114	
S10S - 215/8	150	200	308	295	265	232	204	194	161	12.4	
S10S - 215/9RR	170	225	319	311	281	249	218	206	169	124	
S10S - 215/9R	170	225	330	321	290	255	224	213	175	132	
S10S - 215/9	170	225	344	335	300	263	231	219	183	140	
S10S - 215/10RR	187	250	355	346	314	277	242	230	183	138	
S10S - 215/10R	187	250	367	356	322	283	248	235	195	146	
S10S - 215/10	187	250	381	370	338	291	256	245	201	156	
S10S - 215/11	220	300	425	414	373	327	290	275	230	179	

STAINLESS STEEL SERIES

Nominal Diameter : **10"**

Nominal Flow : **215m³/h**

Outlet Size : **6"**

Performance Curves

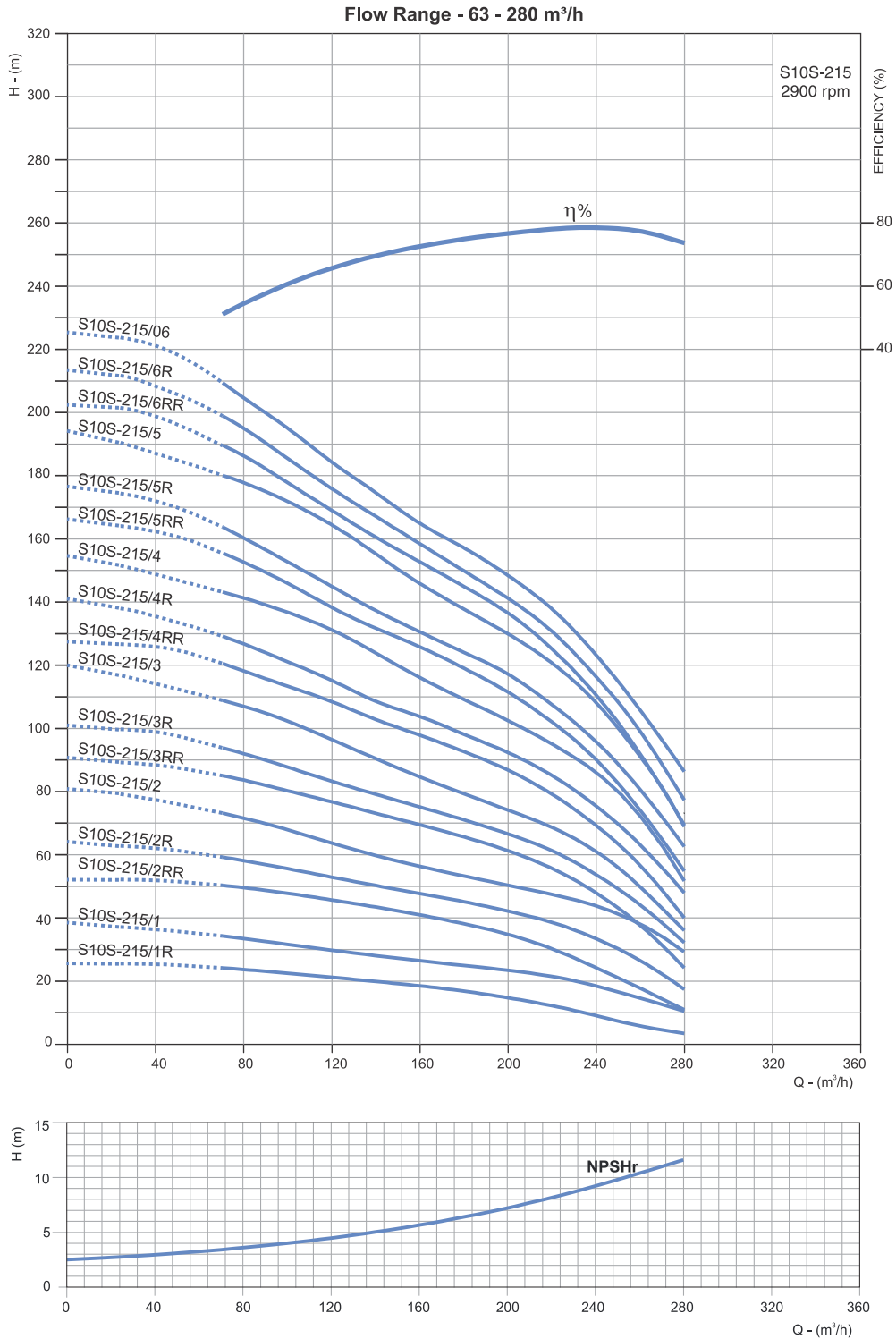

In view of continuous developments, the informations / descriptions / specifications / illustrations are subject to change without notice. Refer general information for performance curve conditions and for other details. Curve tolerance according to ISO : 9906, Grade 3B

STAINLESS STEEL SERIES

Nominal Diameter : **10"**

Nominal Flow : **215m³/h**

Outlet Size : **6"**

Performance Curves

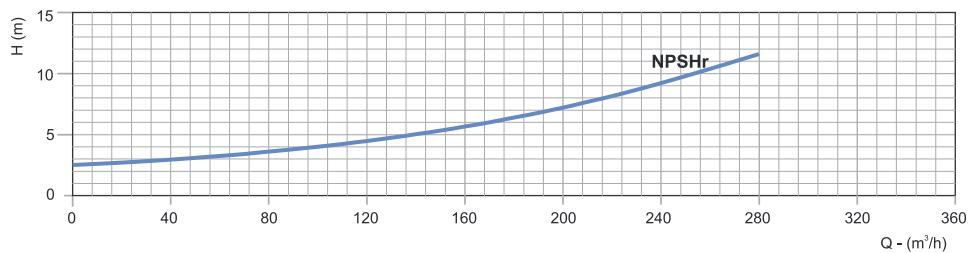
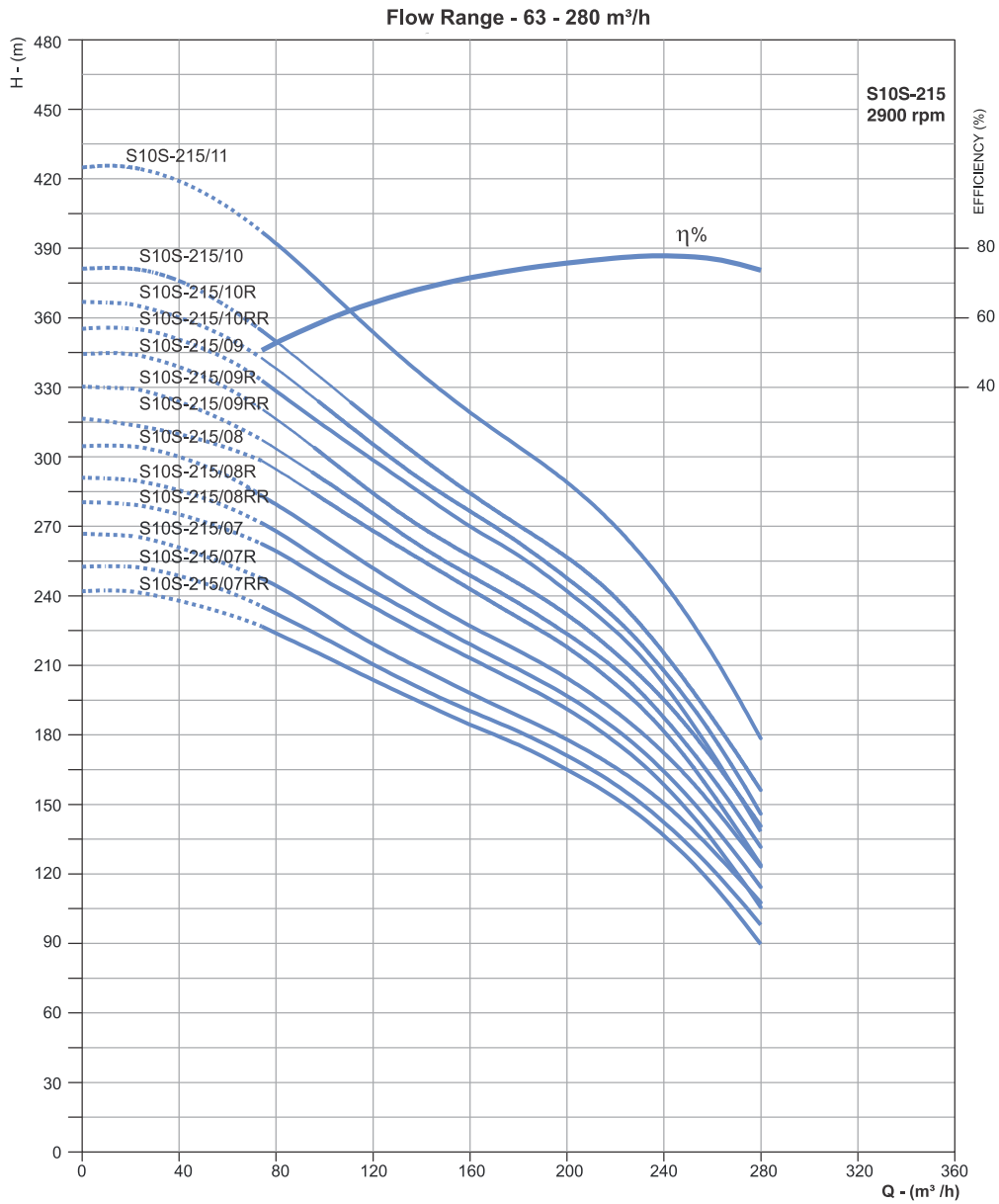

In view of continuous developments, the informations / descriptions / specifications / illustrations are subject to change without notice. Refer general information for performance curve conditions and for other details. Curve tolerance according to ISO : 9906, Grade 3B